



PCE Americas Inc.  
711 Commerce Way  
Suite 8  
Jupiter  
FL-33458  
USA  
From outside US: +1  
Tel: (561) 320-9162  
Fax: (561) 320-9176  
info@pce-americas.com

PCE Instruments UK Ltd.  
Units 12/13  
Southpoint Business Park  
Ensign way  
Hampshire / Southampton  
United Kingdom, SO31 4RF  
From outside UK: +44  
Tel: (0) 2380 98703 0  
Fax: (0) 2380 98703 9  
info@industrial-needs.com

[www.pce-instruments.com/english](http://www.pce-instruments.com/english)  
[www.pce-instruments.com](http://www.pce-instruments.com)

## Non Contact Infrared Thermometer User Manual PCE-675

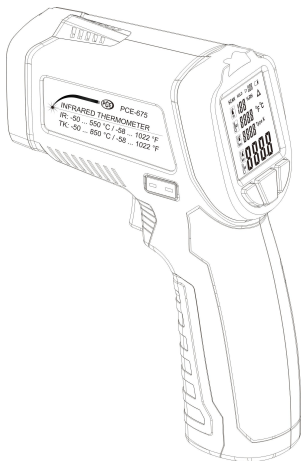

***Please read this user manual thoroughly before using this unit and keep it properly for your future reference.***

## Contents

1. Introduction.....	1
2. Features.....	1
3. Safety.....	2
4. Distance & Spot Size.....	3
5. Specifications.....	5
6. Meter Description.....	7
7. LCD Display Description.....	8
8. Operating Instruction.....	9
9. Measurement Mode.....	12
10. Emissivity.....	16
11. Notes.....	18
12. Accessories.....	19
13. Warraanty.....	20

# 1. Introduction

Congratulations on purchasing our professional non-contact infrared thermometer. This product is a professional, hand-held meter for non-contact Infrared temperature measurement that is simple to use, highly accurate, and has a wide temperature range. It can be used to measure the surface temperature of hard-to-reach or moving objects.

## 2. Features

- Accurate and fast non-contact measurements
- 13 in-built 13 laser pointers increase the target accuracy
- Multifunction thermometer for k-type temperature, surface temperature, ambient temperature, ambient humidity, dew point temperature and wet bulb temperature
- UV light for leak detection
- LED light to enable working in dark environments
- Temperature difference alarm with audible and visual alarm
- Large color LCD display with backlight
- °C / °F selection

- Low power indication
- Auto power off.

### 3. Safety

- Use with extreme caution when the laser beam is turned on.
- Do not point the beam towards eye of anyone or any animals.
- Do not allow the beam to strike the eye from a reflective surface.
- Do not use the laser near explosive gases.



## 4. Distance & Spot Size

When the distance (D) between the thermometer and the object increases, the light spot (S) increases. The distance to the spot ratios are shown below in the field of view diagram.

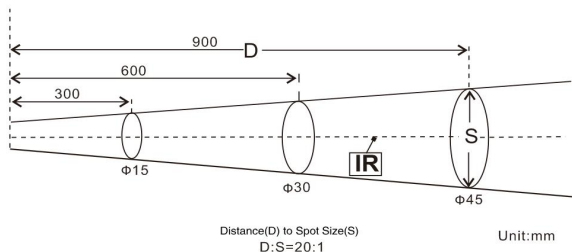
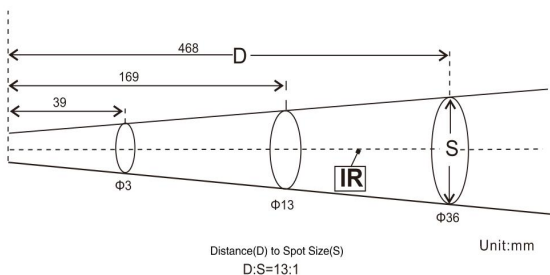

**Notes:**

- Accuracy can be ensured while the temperature is at 18°C to 28°C (64°F~82°F) and humidity is less than 80 % RH.
- Make sure the target is larger than the unit's spot size. The smaller the target, the closer you should be to it. When accuracy is critical, make sure the target is at least twice as large as the spot size.

## 5. Specifications

Temp. range (IR)	-50°C~550°C/-58°F~1022°F
D:S	13:1
IR Accuracy	-50~0°C / -58~32°F: $\pm 3^{\circ}\text{C}$ / $5.4^{\circ}\text{F}$
	> 0°C: $\pm 1.5\%$ or $\pm 2.0$ / $3.6^{\circ}\text{F}$ whichever is greater
Emissivity	Adjustable from 0.1~1.0
Resolution	0.1°C (0.1°F) < 1000 ,1°C (1°F) > 1000
Response Time	< 500ms
Spectral Response	8~14um
Diode Laser	Output < 1mW, 630~670nm, class 2( II ) laser
Range (TK)	-50°C~850°C / -58°F~1562°F
TK Accuracy	$\pm 1.5\%$ or $\pm 1.5$ / $2.7^{\circ}\text{F}$ whichever is greater
Resolution	0.1°C (0.1°F) < 1000 ,1°C (1°F) > 1000
Ambient Temp. Range	-20°C~60°C / -4°F~140°F
Accuracy	0°C~40°C / 32°F~104°F: $\pm 1.0^{\circ}\text{C}$ / $1.8^{\circ}\text{F}$
	Others: $\pm 2.0^{\circ}\text{C}$ / $3.6^{\circ}\text{F}$
Resolution	0.1°C / 0.1°F
Ambient Humidity Range	0~100%RH
Accuracy	35~75%RH: $\pm 3.0\%$ RH
	other; $\pm 5.0\%$ RH

Resolution	1%RH
Dew Point Temp. Range	-20~60°C / -4~140°F
Accuracy	±1.5°C / 2.7°F (25°C / 77°F , 40~80%RH)
Resolution	0.1°C / 0.1°F
Wet-bulb Temp. Range	-20~60°C / -4~140°F
Accuracy	±1.5°C / 2.7°F (25°C / 77°F,40~80%RH)
Resolution	0.1°C / 0.1°F
Auto Power Off	Meter shuts off automatically after around one minute of inactivity
Operation Temp.	0°C~ 50°C / 32°F to 122°F
Storage Temp.	-20°C~70°C / -4°F to 140°F
Relative Humidity	Operating:10 to 95%RH Storage:<80%RH
Power Supply	1*9V battery



## 6. Meter Description

- 1) Temperature and humidity sensor
- 2) Laser pointer
- 3) IR sensor
- 4) Flashlight, UV Light
- 5) K-type probe interface
- 6) Trigger button
- 7) Battery Compartment
- 8) Light On/Off key
- 9) MODE key
- 10) Laser On/Off key
- 11) LCD display screen
- 12) Alarm indicator

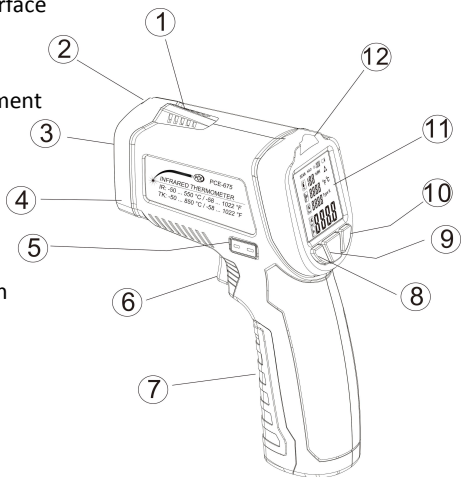

## 7. LCD Display Description

- 1) Measurement and Data hold
- 2) Ambient humidity symbol and reading
- 3) Ambient temperature symbol and reading
- 4) Dew point temperature symbol
- 5) Wet bulb temperature symbol
- 6) Infrared temperature symbol
- 7) Wet bulb and IR temperature reading
- 8) Dew point and K-type Temp reading
- 9) K type temperature symbol
- 10) Temperature unit symbol
- 11) Humidity unit symbol
- 12) Laser symbol
- 13) Emissivity
- 14) Battery level

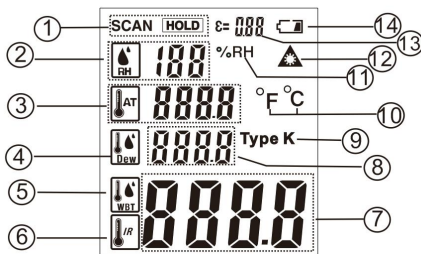

## 8. Operating Instruction

### 8.1 Operating steps:

- a) Hold the meter by its handle grip and point it toward the surface to be measured.
- b) Pull and hold the Trigger to turn the meter on, the "SCAN" icon will appear and begin testing.
- c) Release the trigger, the "HOLD" icon will appear, the readings will be frozen
- d) The meter will automatically shut off after 1 minute of inactivity.

#### Measurement Note :

- ◆ If the meter used in an ambient temperature with a large temperature change, wait it at least 30 minutes to adjust it.
- ◆ The laser is designed for aiming only; it can be shut off while operating in short distance to save the battery.

### 8.2 Button Function

(1)  Key

- a) In HOLD mode, pressing MODE key will enter into the

Mildew alarm mode, Temperature difference alarm mode, Environment detection mode, K-type temperature mode and Emissivity adjustment mode in turn.

- b) In HOLD mode, long pressing the MODE key can switch temperature unit °C or °F.

**(2)**  **Key**

Pressing the flashlight key will momentarily turn on/off the flashlight. Press and hold to turn on/off the UV light.

**(3)**  **Key**

Pressing the laser key will momentarily can turn on/off the laser.

### **8.3 Battery Replacement**

When the low battery icon “” appears, replace the meter's battery.

Open the battery compartment, replace a new 9V battery and then close the battery compartment cover.

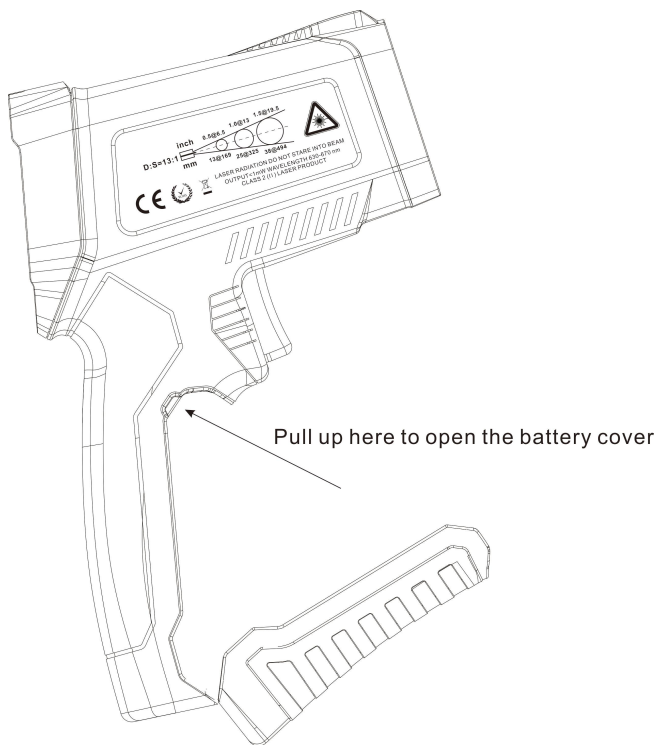

## 9. Measurement Mode

### 9.1 Mildew Alarm Mode

After powering on the meter, press the MODE key to switch to the Mildew alarm mode, the LCD will display as below fig. 1. Press and hold the trigger button, the LCD will display the current measuring ambient humidity, ambient temperature, dew point temperature and surface temperature. The scanned surface temperature will be compared with the dew point temperature automatically to determine whether the target object is mildewed. The LED color will turn Green if it's not mildewed. The LED color will turn Red if it's already been mildewed. The LED color will turn Yellow if it's on the verge of mildew.

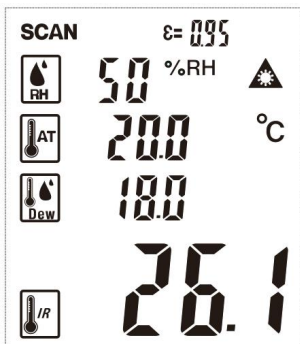

(Fig. 1)

## 9.2 Temperature Difference Alarm Mode

After powering on the meter, press MODE key to switch to the Temperature difference alarm mode, the LCD will display as below fig. 2. Press and hold the trigger button, the LCD will display the current measuring ambient temperature and surface temperature. The scanned surface temperature will be compared with the ambient temperature automatically to determine whether the target object is working properly. The LED color will turn Green if the scanned surface temperature is close to the ambient temperature. The LED color will turn Red if the scanned surface temperature is above around 5°C higher or lower than the ambient temperature. The LED color will turn Yellow if the scanned surface temperature is above around 3°C higher or lower than the ambient temperature.

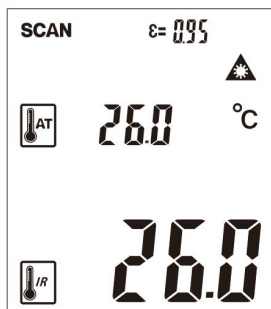

(Fig. 2)

### 9.3 Environment Detection Mode

After powering on the meter, press MODE key to switch to the Environment detection mode, the LCD will display as below fig. 3. Press and hold the trigger button, the LCD will display the current measuring ambient humidity, ambient temperature, dew point temperature and wet-bulb temperature simultaneously.

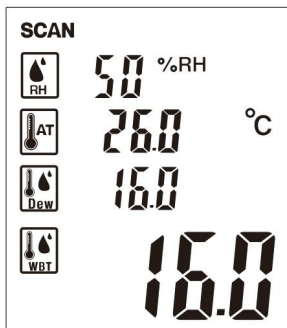

(Fig. 3)

### 9.4 K-type Temperature Mode

After powering on the meter, press MODE key to switch to the K-type temperature mode, the LCD will display as below fig. 4. Insert a K-type thermocouple probe into the probe socket. Press and hold the trigger button, the LCD will display the current



measuring ambient temperature, K-type temperature and surface temperature simultaneously.

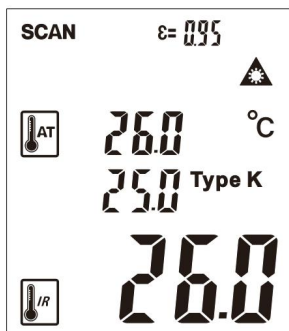

(Fig. 4)

### 9.5 Emissivity Set

After power on the meter, press MODE key to switch to the Emissivity set mode, the LCD will display as below fig. 5. In the

emissivity adjustment mode, press  key to increase the value

and press  key to decrease the value.

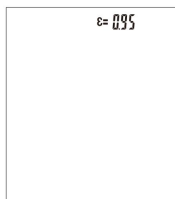

(Fig. 5)

## 9.6 UV light

The UV light could be used for fluorescent leak detection to find all system leaks quickly and easily.

**Fluorescent leak detection:** Add or inject the fluorescent agent into the system and let it circulate with host fluid. Once circulation is completed, use UV light to inspect for leak sites. The agent will be fluorescent by the UV light, so that we can locate the leak sites.

## 10. Emissivity

The emissivity of the surface of a material is its effectiveness in emitting energy as thermal radiation. It is the ratio of the thermal radiation from a surface to the radiation from an ideal black surface at the same temperature. The ratio varies from 0 to 1. The bigger the ratio, the stronger the thermal radiation is from the surface. The emissivity of surface of most materials is between 0.85~0.98. The default emissivity of this unit is set at 0.95; however, it can be adjustable. Before measuring, please adjust it to the suitable emissivity according to below table.

## Emissivity Table

<b>Substance</b>	<b>Thermal emissivity</b>	<b>Substance</b>	<b>Thermal emissivity</b>
Aluminum	0.30	Glass	0.90 to 0.95
Asphalt	0.95	Iron oxides	0.78 to 0.82
Concrete	0.95	Lacquer	0.80 to 0.95
Asbestos	0.95	Plastic	0.85 to 0.95
Ceramic	0.95	Paper	0.70 to 0.94
Copper	0.50	Sand	0.90
Brick	0.90	Rubber	0.95
Carbon	0.85	Timber	0.94
Fat-lute	0.94	Textiles	0.94
Frozen food	0.90	Lead	0.50
Hot food	0.93	Marble	0.94
Ice	0.98	Cloth black	0.98
Snow	0.90	Plaster	0.80 to 0.90
Human skin	0.98	Water	0.93

# 11. Notes

## (1) Working principle

- The infrared thermometer is designed for measuring surface temperature of an object.
- The optical sensor can emit, reflect and transmit energy, which is collected and focused on a detector, then translate it into the temperature reading by electronics and displayed on the LCD screen.
- The laser is used for aiming the target object only.

## (2) Field of View

- The object under test should be larger than the spot size calculated by the field of view diagram.
- The smaller the target object is, the closer the meter should be to it for accurate measuring.
- When accuracy is critical, make sure the target is at least twice as large as the spot size.

## (3) Distance & Spot Size

As distance ( $D$ ) from the object increases, the spot size ( $S$ ) of the area measured by the unit becomes larger.

#### **(4) Locating a hot Spot**

To find a hot spot, first aim the thermometer to the outside of target area, then scan across in an up and down motion until the hot spot is located.

#### **(5) Notice**

- Not recommend for measuring shiny or polished metal surfaces like stainless steel, aluminum, etc.
- Do not make measurement through transparent surface such as glass
- If the surface of the object under test is covered with frost, oil, grease, etc., clean it before taking measurement.

#### **(6) Maintenance**

- Do not use volatile liquids to clean the unit, wipe it with dry soft cloth.
- Do not disassemble the unit
- Do not immerse it in water.
- Do not store it in high temperature or humidity

## **12. Accessories**

(1) User's Manual

(2) Carry pouch

(3) K-type temperature probe

(4) one 9V Battery

## **13. Warranty**

You can read our warranty terms in our General Business Terms which you can find here:

[https://www.pce-instruments.com/english/terms.](https://www.pce-instruments.com/english/terms)