



User Manual

PCE-CT 100N Coating Thickness Gauge



User manuals in various languages (français, italiano, español, português, nederlands, türk, polski, русский, 中文) can be found by using our product search on: www.pce-instruments.com

Last change: 5 May 2020
v1.0



Contents

1	Safety notes	1
2	Specifications	2
3	Package contents	2
4	Characteristics	2
5	Measuring Principles	3
6	Device Layout	4
7	Screen Layout	5
8	Operation Instructions	5
8.1	Basic measurement steps	5
8.2	Measurement process	6
8.3	Measurement setup	7
8.4	Gauge settings	9
8.5	Data processing	11
9	Calibration	15
10	Maintenance and Repair	15
10.1	Environmental requirements	15
10.2	Battery replacement	16
11	Testing Probe Reference	16
11.1	Organic coatings reference table	16
11.2	Non-magnetic metal coatings reference table	16
12	Warranty	17
13	Disposal	17

1 Safety notes

Please read this manual carefully and completely before you use the device for the first time. The device may only be used by qualified personnel and repaired by PCE Instruments personnel. Damage or injuries caused by non-observance of the manual are excluded from our liability and not covered by our warranty.

- The device must only be used as described in this instruction manual. If used otherwise, this can cause dangerous situations for the user and damage to the meter.
- The instrument may only be used if the environmental conditions (temperature, relative humidity, ...) are within the ranges stated in the technical specifications. Do not expose the device to extreme temperatures, direct sunlight, extreme humidity or moisture.
- Do not expose the device to shocks or strong vibrations.
- The case should only be opened by qualified PCE Instruments personnel.
- Never use the instrument when your hands are wet.
- You must not make any technical changes to the device.
- The appliance should only be cleaned with a damp cloth. Use only pH-neutral cleaner, no abrasives or solvents.
- The device must only be used with accessories from PCE Instruments or equivalent.
- Before each use, inspect the case for visible damage. If any damage is visible, do not use the device.
- Do not use the instrument in explosive atmospheres.
- The measurement range as stated in the specifications must not be exceeded under any circumstances.
- Non-observance of the safety notes can cause damage to the device and injuries to the user.

We do not assume liability for printing errors or any other mistakes in this manual.

We expressly point to our general guarantee terms which can be found in our general terms of business.

If you have any questions please contact PCE Instruments. The contact details can be found at the end of this manual.



2 Specifications

Measurement range	0 ... 1250 μm
Accuracy	$\pm(1\% + 1\ \mu\text{m})$
Resolution	0.1 μm (<99.9 μm) 1 μm (>100 μm)
Calibration method	One point/two point
Memory	500 data
Measuring method	Single measurement/continuous measurement
Communication interface	Wi-Fi, USB
Operating conditions	0 ... 50 °C, 20 ... 90 % RH not condensed
Dimensions	170 x 85 x 35 mm
Weight	approx. 335 g (with battery)

3 Package contents

- 1 x Coating Thickness Gauge PCE-CT 100N
- 1 x NFe Probe
- 1 x Fe Probe
- 1 x USB-Storage
- 1 x Reference foil set
- 1 x Aluminium/Iron calibration plate
- 2 x 1.5 V AA Batteries
- 1 x User Manual

4 Characteristics

- WIFI function
- Touch screen
- Uses magnetic and eddy current thickness measurement method to measure:
 - magnetic metal substrate thickness of non-conductive coating
 - thickness of non-magnetic coating layers
 - non-magnetic metal substrates
- Two probe types:
 - Ferrous (Fe)
 - Non-Ferrous (NFe)
- Two measurement modes:
 - Continuous measurement mode (CONTINUE)
 - Single measurement mode (SINGLE)
 - Both methods can be used to calibrate the instrument, while basic calibration methods can be used to detect system error corrections
- Two operating modes:
 - Direct mode (DIRECT)
 - Group means (AB)

- Five statistics:
 - Average (MEAN)
 - Maximum (MAX)
 - Minimum (MIN)
 - Number of tests (NO.)
 - Standard deviation (S.DEV)
- Storage function:
 - 500 measurements for storage
- Delete function:
 - Single or multiple entry deletion
- Threshold Setting
 - For measured values outside of the gauge's automatic alarm
- USB Storage:
 - measured values can be stored on a USB flash drive in text format
- Beep alerts during operation
- Automatic and manual shutdown

5 Measuring Principles

The gauge uses magnetic and eddy current thickness measurement methods. The non-destructive measurement can measure the thickness of magnetic metals (such as steel, iron, alloy steel) and hard magnetic and non-magnetic coatings (such as aluminium, chromium, copper, enamel, rubber, paint, etc.); the thickness of non-conductive coatings (such as enamel paint, plastic, rubber, etc.) of non-magnetic metals (such as copper, aluminium, zinc, tin, etc.).

Magnetic measurement method:

- When the (Fe) probe comes into contact with a metal surface, the magnetic field will be amplified. It then generates a voltage in a second coil (measuring coil). This voltage depends on the distance from the metal surface. If a non-magnetic coating is present, a defined distance results between the probe and the metal surface, and thus a defined coil voltage. This is electronically evaluated and digitally displayed as the coating thickness.

Eddy current measuring method:

- When the (NFe) probe with its alternating field approaches a non-ferrous metal, an alternating current – called the eddy current – is induced in this metal. This produces another electro-magnetic alternating field in the opposite direction, weakening the original field. The effect in the probe is a change of inductiveness. By placing the probe in contact with the coating, a defined distance between the probe and the non-ferrous metal results, thus leading to a defined inductivity. This will be electronically evaluated and digitally displayed as the coating thickness.

6 Device Layout



1. Display Screen
2. Zero-In Calibration
3. Backlight
4. Navigation Keys
5. Menu
6. File Browser
7. Back

8. NFe Probe
9. Fe Probe
10. On/Off Switch
11. Probe Input
12. Stand
13. USB Port

7 Screen Layout

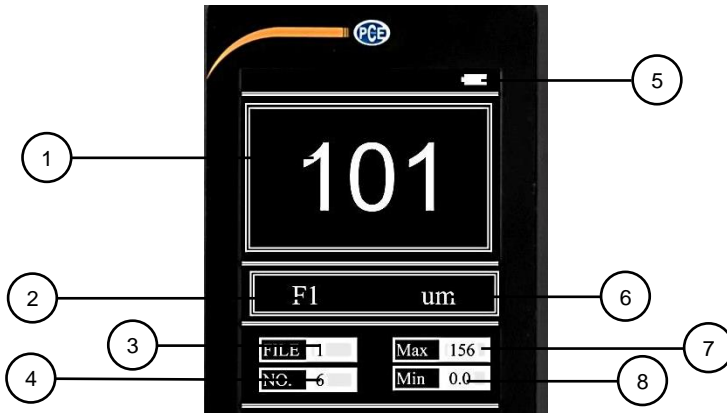

- | | |
|-----------------------|------------------------|
| 1. Measurement result | 5. Battery status |
| 2. Measurement mode | 6. Unit of measurement |
| 3. File number | 7. Max threshold |
| 4. Measurement count | 8. Min threshold |

8 Operation Instructions

8.1 Basic measurement steps

8.1.1 Sample piece surface preparation

- The preparation of the sample surface must comply with the relevant requirements in chapter 11.
- In the process of preparing the sample surface, the temperature on the sample surface should be avoided as much as possible.
- If the surface to be tested is too rough, it will cause measurement errors. Therefore, the sample surface must be exposed to metallic luster and be smooth and oil-free.
- Surface: A flat test surface is preferable. A sample surface with a radius of curvature of less than 30 mm must be tested with a small support ring or a profiled support ring.

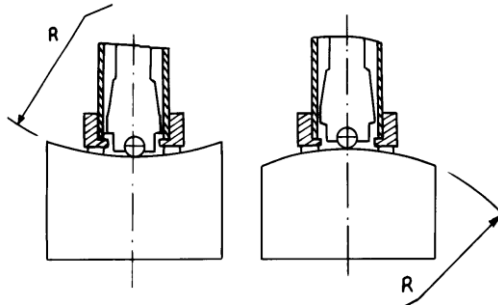



- Sample support
 - For heavy sample pieces: no support is required
 - For medium sized pieces: the sample must be placed on a flat, stable surface with no shaking.
- The minimal sample surface thickness must comply with the requirements of Table 3.
- For hard surface layers, the depth of the layer must comply with the requirements of Table 3.
- Coupling:
 - Light samples must be tightly coupled with a strong support. The two coupling surfaces must be flat and smooth, and the amount of coupling agent should not be excessive. The test direction must be perpendicular to the coupling plane.
 - If the sample is a large-area plate, long rod, or bent; even if the weight or thickness are large, the sample piece may be deformed or unstable, this will result in inaccurate test values. Therefore, the sample should be reinforced or supported on the back side of the sample piece.
- The sample surface should not exceed 30 Gauss.

8.2 Measurement process

Before measurement, the instrument can be tested with a random test block. The indication error and repeatability should not exceed the requirements of table 1.

Repeatability [µm]	1-point calibration (µ)	±(3 %H + 0.7)	±(3 %H + 1)	±(3 %H + 10)	±(3 %H + 0.7)	±(3 %H + 1.5)	±(3 %H + 1)
	2-point calibration (m)	±(1 %H + 0.7)	±(1 %H + 1)	±(1 %H + 10)	±(1 %H + 0.7)	±(1 %H + 1.5)	-

Table 1

Note: the random test block must be measured with a calibrated device.

8.2.1 Measurement procedure

- Insert the probe into the probe input on the device.
- The probe must be placed into the test sample. The probe, sample and operator must now remain perfectly stable and the probe should be as perfectly perpendicular to the sample as possible.
- If the resulting value exceeds the measurable amount, the device will need to be calibrated separately with 5 test pieces.
- The distance between any two indentations or the distance from the centre of any indentation must comply with table 2.

Distance between two indentation centres	Indentation centre distance from the edge of the sample
not less than	not less than
3mm	5mm

Table 2

8.3 Measurement setup

- Press the Menu button to enter the Instrument Menu Settings screen; the screen displays the nine options for the first level menu.



- Use the ◀ or ▶ buttons to navigate the menu to the measure icon.
- Press the menu button (≡) to enter the measurement settings.
- Press the back button to end the setup and return to the previous menu.

8.3.1 Unit setup

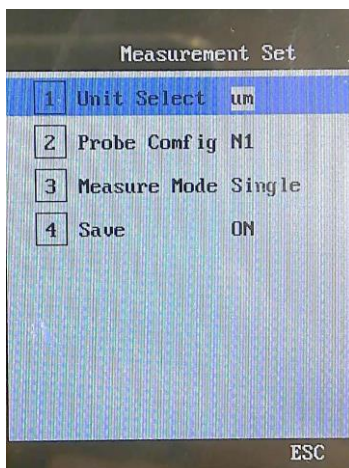

- Use the ▲ and ▼ buttons to navigate the menu to the unit select setting.
- Use the ◀ or ▶ buttons to change the selected value.
- Press the back button to end the setup and return to the previous menu.

8.3.2 Probe setup

- Use the ▲ and ▼ buttons to navigate the menu to the probe configuration.
- Use the ◀ or ▶ buttons to change the selected value.
- Press the back button to end the setup and return to the previous menu.
- Probe replacement:
 - Turn the device off
 - Replace the probe
 - Turn the device back on. The probe config. setting has now been automatically changed.

8.3.3 Measurement mode

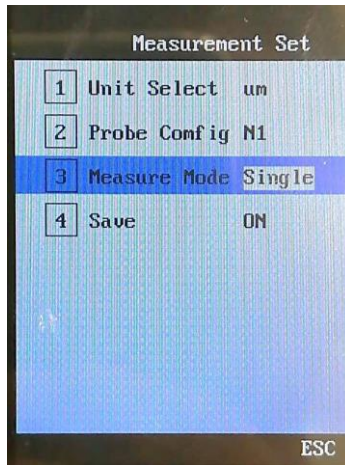

- Use the ▲ and ▼ buttons to navigate the menu to the measurement mode.
- Use the ◀ or ▶ buttons to change the selected value.
- Press the back button to end the setup and return to the previous menu.

8.3.4 Automatic storage

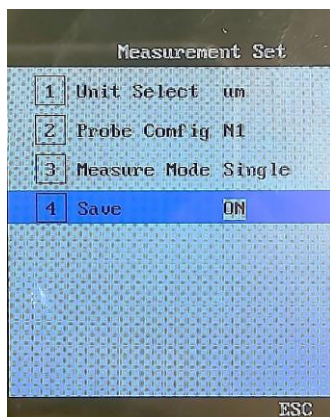

- Use the ▲ and ▼ buttons to navigate the menu to the save mode.
- Use the ◀ or ▶ buttons to change the selected value.
- Press the back button to end the setup and return to the previous menu.

8.4 Gauge settings

- Press the Menu button to enter the Instrument Menu Settings screen.
- Use the ◀ or ▶ buttons to navigate the menu to the gauge icon.
- Press the menu button (≡) to enter the gauge settings.
- Press the back button to end the setup and return to the previous menu.

8.4.1 Touch tone settings



- Use the ▲ and ▼ buttons to navigate the menu to the touch tone setting.
- Use the ◀ or ▶ buttons to change between on and off.
- Press the back button to end the setup and return to the previous menu.

8.4.2 Backlight settings

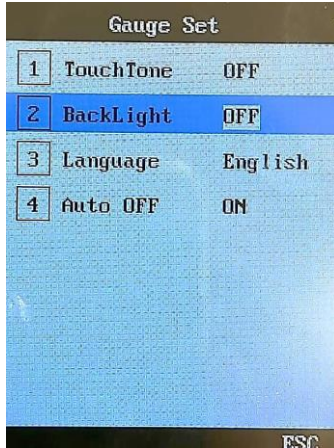

- Use the ▲ and ▼ buttons to navigate the menu to the backlight setting.
- Use the ◀ or ▶ buttons to change between on and off.
- Press the back button to end the setup and return to the previous menu.

8.4.3 Language settings

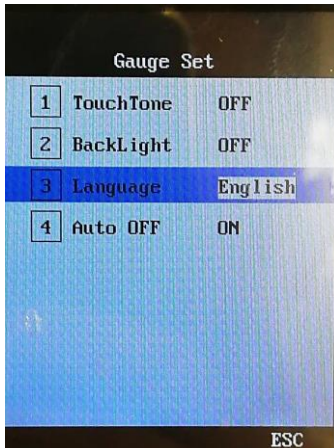

- Use the ▲ and ▼ buttons to navigate the menu to the language setting.
- Use the ◀ or ▶ buttons to change between English and Chinese.
- Press the back button to end the setup and return to the previous menu.

8.4.4 Auto shut down settings



- Use the ▲ and ▼ buttons to navigate the menu to the auto off setting.
- Use the ◀ or ▶ buttons to change between on and off.
- Press the back button to end the setup and return to the previous menu.

8.5 Data processing

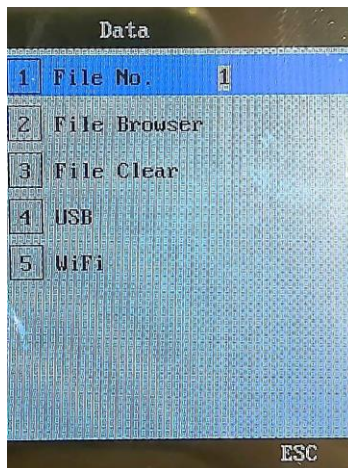

The device has a variety of data processing functions, including on-board storage, browsing, and deletion of data. The data can be transferred in two ways:

- The internal data can be transferred to a USB drive through the USB interface. This data can then be transferred from the USB drive onto a computer.
- The data can be transferred over WIFI to another device (mobile/PC).

8.5.1 USB memory

The device can directly store data to a USB drive. The USB port can only be used to store data to a USB drive; it cannot be used to connect the device directly to a PC.



- Press the Menu button to enter the Instrument Menu Settings screen.
- Use the navigational buttons to navigate the menu to the USB icon.
- Press the menu button (≡) to enter the USB settings.
- Insert a USB drive into the USB port and press the menu button (≡) to begin the data storage process.
- A message box with "Ok!" will be displayed once the process is complete.
- Press the back button to end the setup and return to the previous menu.
- The data can now be read from the USB drive either on a PC or with the file browser on the device.

8.5.2 WIFI connection

The device can transfer data over WIFI to another device (mobile/PC).

- Transfer the app from the USB pen drive to your computer.
- Then connect your Android device to your computer and transfer the app file to your Android device.
- Open the file and install the app.
- Start the WiFi connection on the PCE-CT 100N.



- Connect your Android device to the PCE-CT 100N via WiFi.
- In the Android device, select the option "Measurement" to receive the values.

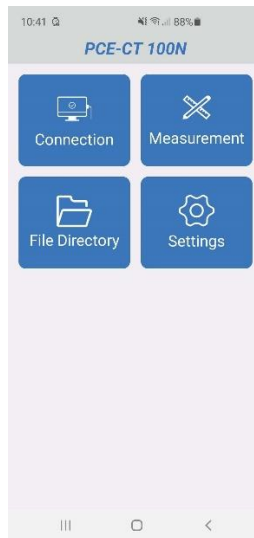

- Press the MENU key on the meter. In the menu, you have the following options:
 - Send group – here you can select what memory group you would like to transfer to your Android device
 - Real time – send data in real time
 - Turn off WiFi

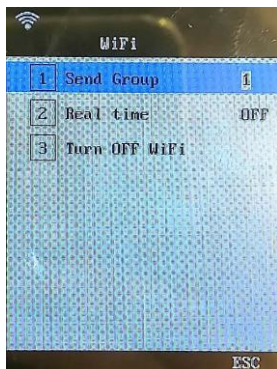

- After selecting one of the two options, the readings will be displayed directly.

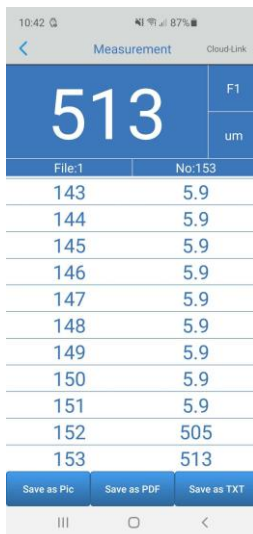

- After receiving the values, you can save these as a picture, as .pdf or .txt files.

8.5.3 File processing

- Press the Menu button to enter the Instrument Menu Settings screen.
- Use the navigational buttons to navigate the menu to the data icon.
- Press the menu button (≡) to enter the data settings.
- Select the File No. setting and use the ◀ or ▶ buttons to change the file set number. The device supports up to 5 file sets.
- Select the File Browser and use the ▼ to ▲ buttons to navigate the 5 file sets. Use the menu button (≡) to view a file set. Each file set can contain up to 28 data sets.
- Select File Clear and use the menu button (≡) to confirm the process. The entire selected file set will be cleared.

9 Calibration

The device and impact probe must be calibrated with a coating thickness matrix before first use or after a prolonged period of non-use.



- Press the Menu button to enter the Instrument Menu Settings screen.
- Use the navigational buttons to navigate the menu to the calibrate icon.
- Press the menu button (≡) to enter the data settings.

6 measurements must be performed vertically down into the provided substrate; the first is a zero calibration (without the substrate).

- Use the ▲ or ▼ buttons to adjust the value to the nominal thickness of the standard test substrate for each measurement.
- Perform a total of 5 measurements; one test for one test foil.
- Press the menu button (≡) to save and exit the calibration process.

10 Maintenance and Repair

10.1 Environmental requirements

Strictly avoid collisions, heavy dust, moisture, strong magnetic fields, oil stains, and other dirtying or damaging factors.

10.2 Battery replacement

The battery life for this is typically 3 years. After the batteries fail, the user can replace them as follows:

- Switch the device off.
- Unscrew and separate the battery cover on the back of the main unit.
- Replace the drained batteries.
- Replace the cover and tighten the screw.

11 Testing Probe Reference

11.1 Organic coatings reference table

Coating / Base		Organic materials and other non-metallic coatings (such as: paint, enamel, etc.)	
		Cover thickness < 100µm	Cover thickness > 100µm
Magnetic metal (Iron, Steel, etc.)	Measuring area > 30mm	F400: 0~400µm F1: 0~1250µm	F400: 0~400µm F1: 0~1250µm F10: 0~10mm
	Measuring area < 30mm	F400: 0~400µm	F1: 0~1250µm F400: 0~400µm
Copper, Aluminium, Tin, etc.	Measuring area > 10mm	N400: 0~400µm N1: 0~1250µm	N400: 0~400µm N1: 0~10mm
	Measuring area < 10mm	N400: 0~400µm	N1: 0~1250µm N400: 0~400µm

11.2 Non-magnetic metal coatings reference table

Coating / Probe		Non-magnetic metal layer (such as: chromium, zinc, aluminium, copper, tin, silver, etc.)	
		Cover thickness < 100µm	Cover thickness > 100µm
Magnetic metal (Iron, Steel, etc.)	Measuring area > 30mm	F400: 0~400µm F1: 0~1250µm	F400: 0~400µm F1: 0~1250µm F10: 0~10mm
	Measuring area < 30mm	F400: 0~400µm	F1: 0~1250µm F400: 0~400µm
Copper, Aluminium, Tin, etc.	Measuring area > 10mm	Only for copper plating N400: 0~40µm
	Measuring area < 10mm
Plastic, non-metal base	Measuring area > 7mm	Cn02: 10~200µm	Cn02: 10~200µm

12 Warranty

You can read our warranty terms in our General Business Terms which you can find here: <https://www.pce-instruments.com/english/terms>.

13 Disposal

For the disposal of batteries in the EU, the 2006/66/EC directive of the European Parliament applies. Due to the contained pollutants, batteries must not be disposed of as household waste. They must be given to collection points designed for that purpose.

In order to comply with the EU directive 2012/19/EU we take our devices back. We either re-use them or give them to a recycling company which disposes of the devices in line with law.

For countries outside the EU, batteries and devices should be disposed of in accordance with your local waste regulations.

If you have any questions, please contact PCE Instruments.





PCE Instruments contact information

Germany

PCE Deutschland GmbH
Im Langel 4
D-59872 Meschede
Deutschland
Tel.: +49 (0) 2903 976 99 0
Fax: +49 (0) 2903 976 99 29
info@pce-instruments.com
www.pce-instruments.com/deutsch

Germany

PCE Produktions- und
Entwicklungsgesellschaft mbH
Im Langel 26
D-59872 Meschede
Deutschland
Tel.: +49 (0) 2903 976 99 471
Fax: +49 (0) 2903 976 99 9971
info@pce-instruments.com
www.pce-instruments.com/deutsch

The Netherlands

PCE Brookhuis B.V.
Institutenweg 15
7521 PH Enschede
Nederland
Telefoon: +31 (0)53 737 01 92
info@pcebenelux.nl
www.pce-instruments.com/dutch

United States of America

PCE Americas Inc.
711 Commerce Way suite 8
Jupiter / Palm Beach
33458 FL
USA
Tel: +1 (561) 320-9162
Fax: +1 (561) 320-9176
info@pce-americas.com
www.pce-instruments.com/us

France

PCE Instruments France EURL
23, rue de Strasbourg
67250 Soultz-Sous-Forets
France
Téléphone: +33 (0) 972 3537 17
Numéro de fax: +33 (0) 972 3537 18
info@pce-france.fr
www.pce-instruments.com/french

United Kingdom

PCE Instruments UK Ltd
Unit 11 Southpoint Business Park
Ensign Way, Southampton
Hampshire
United Kingdom, SO31 4RF
Tel: +44 (0) 2380 98703 0
Fax: +44 (0) 2380 98703 9
info@pce-instruments.co.uk
www.pce-instruments.com/english

China

PCE (Beijing) Technology Co., Limited
1519 Room, 6 Building
Zhong Ang Times Plaza
No. 9 Mentougou Road, Tou Gou District
102300 Beijing, China
Tel: +86 (10) 8893 9660
info@pce-instruments.cn
www.pce-instruments.cn

Turkey

PCE Teknik Cihazları Ltd.Şti.
Halkalı Merkez Mah.
Pehlivan Sok. No.6/C
34303 Küçükçekmece - İstanbul
Türkiye
Tel: 0212 471 11 47
Faks: 0212 705 53 93
info@pce- cihazlari.com.tr
www.pce-instruments.com/turkish

Spain

PCE Ibérica S.L.
Calle Mayor, 53
02500 Tobarra (Albacete)
España
Tel. : +34 967 543 548
Fax: +34 967 543 542
info@pce-iberica.es
www.pce-instruments.com/espanol

Italy

PCE Italia s.r.l.
Via Pesciatina 878 / B-Interno 6
55010 Loc. Gragnano
Capannori (Lucca)
Italia
Telefono: +39 0583 975 114
Fax: +39 0583 974 824
info@pce-italia.it
www.pce-instruments.com/italiano

Hong Kong

PCE Instruments HK Ltd.
Unit J, 21/F., COS Centre
56 Tsun Yip Street
Kwun Tong
Kowloon, Hong Kong
Tel: +852-301-84912
jyi@pce-instruments.com
www.pce-instruments.cn