



# User Manual

PCE-DPM 3 Dew Point Thermometer



User manuals in various languages (français, italiano, español, português, nederlands, türk, polski, русский, 中文) can be found by using our product search on: [www.pce-instruments.com](http://www.pce-instruments.com)

Last change: 6 October 2020  
v1.0



## Contents

<b>1</b>	<b>Safety notes</b> .....	<b>1</b>
<b>2</b>	<b>Specifications</b> .....	<b>2</b>
<b>3</b>	<b>Device description</b> .....	<b>3</b>
3.1	Keyboard description.....	4
<b>4</b>	<b>Measurement window</b> .....	<b>4</b>
<b>5</b>	<b>Main menu and symbols</b> .....	<b>5</b>
5.1	Functions .....	5
5.2	Recording function .....	6
5.3	Display settings .....	7
5.4	Environmental parameters/ measurement settings .....	8
5.5	Further settings .....	9
<b>6</b>	<b>Warranty</b> .....	<b>10</b>
<b>7</b>	<b>Disposal</b> .....	<b>10</b>

## 1 Safety notes

Please read this manual carefully and completely before you use the device for the first time. The device may only be used by qualified personnel and repaired by PCE Instruments personnel. Damage or injuries caused by non-observance of the manual are excluded from our liability and not covered by our warranty.

- The device must only be used as described in this instruction manual. If used otherwise, this can cause dangerous situations for the user and damage to the meter.
- The instrument may only be used if the environmental conditions (temperature, relative humidity, ...) are within the ranges stated in the technical specifications. Do not expose the device to extreme temperatures, direct sunlight, extreme humidity or moisture.
- Do not expose the device to shocks or strong vibrations.
- The case should only be opened by qualified PCE Instruments personnel.
- Never use the instrument when your hands are wet.
- You must not make any technical changes to the device.
- The appliance should only be cleaned with a damp cloth. Use only pH-neutral cleaner, no abrasives or solvents.
- The device must only be used with accessories from PCE Instruments or equivalent.
- Before each use, inspect the case for visible damage. If any damage is visible, do not use the device.
- Do not use the instrument in explosive atmospheres.
- The measurement range as stated in the specifications must not be exceeded under any circumstances.
- Non-observance of the safety notes can cause damage to the device and injuries to the user.

We do not assume liability for printing errors or any other mistakes in this manual.

We expressly point to our general guarantee terms which can be found in our general terms of business.

If you have any questions please contact PCE Instruments. The contact details can be found at the end of this manual.

## 2 Specifications

Function	Measurement range	Resolution	Accuracy at 20 °C / 68 °F
Temperature	-10 ... 60 °C (+14 ... 140 °F)	0.01 °C (0.018 °F)	-10 ... 50 °C: ±0.3 °C (+14 ... 122 °F: ±0.54 °F)
Relative humidity	0 ... 100 %	0.01 %	<5 %: ±(0.025 % + 17.5 % of VAT ) >5 %: ±(1 % + 5 % of VAT ) >15 %: ±(2 % + 3 % of VAT)
Dew point	-50 ... 30 °C (-58 ... 86 °F)	0.01 °C (0.018 °F)	-40 ... 20 °C: ±2 °C -50 ... -40 °C ±2.5 °C
H2O	40 ... 20.000 ppm	1 ppm	±(7.3 ppm + 8.3 %)
The accuracy of the dew point is based on an ambient temperature of 16 ... 25 °C / 61 ... 77°F			
<b>Further specifications</b>			
Environmental conditions		-10 ... 60 °C (14 ... 140 °F) 0 ... 20 bar (absolute)	
Response time at: 0.2 m/s, 1 bar, 20 °C (68 °F), 63 % RH [90 %].		0 ... 40 °C (-40 ... 32 °F): 20 s [120 s] -40 ... 0 °C (-40 ... 32 °F): 10 s [20 s]	
Data memory		for approx. 50.000 measuring points	
Adjustable storage rates		10 seconds 1, 5, 10, 20, minutes	
Adjustable recording time		1, 5, 12, 24, 48 hours	
File format		CSV	
Cable length		approx. 1.5 m	
Thread		G1/2 "	
Thread length		1.2 cm	
Probe length		5.2 cm	
Probe width		1.2 cm	
Display		Ø5.9 cm LCD	
Power supply - battery		3.7 V, 3000 mAh	
Power supply – mains adaptor		Primary: 100 ... 240 VAC, 0.25 A Secondary: 5 VDC, 1 A	
Interface / mains connection		via micro USB	
Weight		approx. 610 g	

### 3 Device description

No.	Description
1	Display
2	Back key
3	On/off switch, hold key
4	Arrow left key
5	Interface 1 ( <b>no function</b> )
6	Micro USB interface
7	Enter key
8	Arrow up key
9	Arrow right key
10	Arrow down key
11	Interface 2 for connecting the probe
12	G1/2" connection thread
13	Handle of the probe

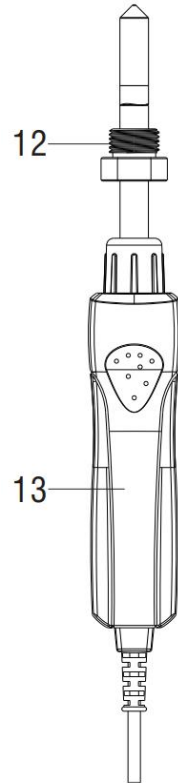
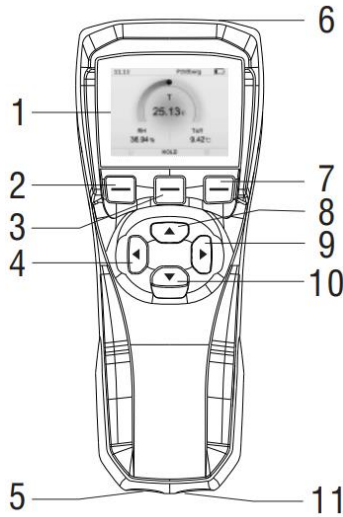

### 3.1 Keyboard description

No.	Description	Function
1	Back key	Go back one menu level
2	On/off switch, hold key	Press and hold the key to switch the meter on and off. Press the key briefly once to freeze the display.
3	Arrow keys up and down	Navigating in the menu / changing parameters
4	Enter key	Confirming an entry / entering the menu
5	Arrow keys left and right	Navigating in the menu / changing parameters

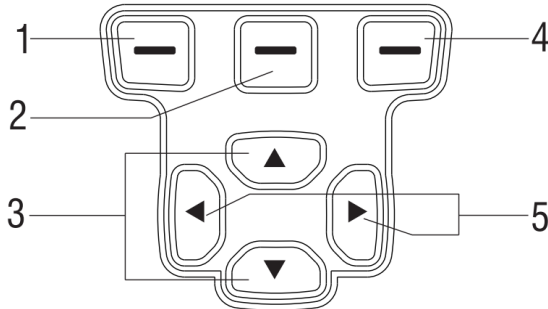

### 4 Measurement window



Use the arrow keys to change the appearance of the measurement window. Two different versions are available.

In addition, you can hold the currently displayed values with the hold key and save them with the enter key (4) according to your preference. To exit hold mode, press the back key (1). Then press the back key (1) to view the saved values in the measurement window.

## 5 Main menu and symbols

Open the main menu by pressing the enter key.

Select the desired menu symbol with the left and right keys or return with the left function key.



### 5.1 Functions

In the "Functions" setting on the left, you can make changes to the alarm functions. Select the item "Setting" with the left or right key.

Alarm settings: Select between Td/f (dew point), T (temperature) or RH (relative humidity) with the enter key.

#### Setting the upper limit value:

Use the arrow down key to select the item "High Limit" and then press the enter key. Now you can enter a value with the up and down keys and confirm it by pressing the enter key again.

#### Setting the lower limit value:

Use the arrow down key to go to the item "Low Limit" and then press the enter key. Now you can enter a value with the up and down keys and confirm it by pressing the enter key again.

#### Alarm on/off:

Use the arrow keys to select On/Off and press the enter key to activate the alarm. If the measured value exceeds the high limit value or falls below the low limit value, the bell symbol appears at the top and an acoustic signal can be heard. Press the enter key again to deactivate the alarm.





### Connect computer:

Select this item if you want to transfer the data to a computer. Do not leave this menu item during the transfer. The data is displayed in an Excel chart.

## 5.2 Recording function

To save the data of the measuring device, select the menu item "Recording" with the left or right arrow key. Now you can activate or deactivate data saving with the enter key.

Recording interval ("Record gap"): 10 s, 1 min, 5 min, 20 min selectable

Record Time: 1 hour, 5 hours, 10 hours, 12 hours, 24 hours, 48 hours

The meter can save up to 32 files. One file contains 1000 data records. The capacity is therefore  $32 \times 1000 = 32000$  records.

**Note:** If it is necessary to record for more than 6 hours, it is recommended to connect the instrument to a power supply to prevent power-related failure of the instrument.

The recorded data is saved in CSV format and can therefore be easily opened on a terminal device with Excel.

**Attention:** Make sure to save the data to your computer.

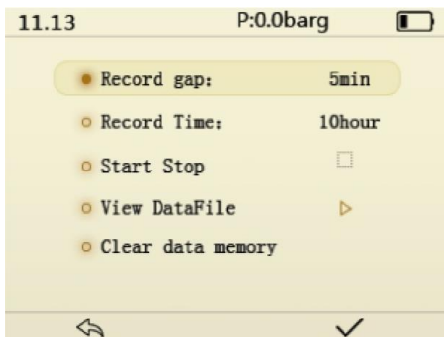

Display data: By means of the menu item "View DataFile", you can open and display the CSV data file via the device.

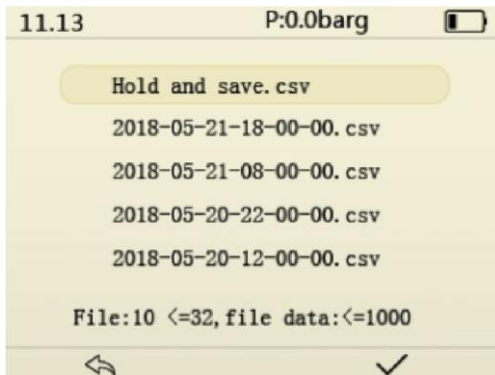



To view the saved data, press the right or left key. To view the next or previous data, press the up/down arrow keys to scroll through the data in steps of ten.

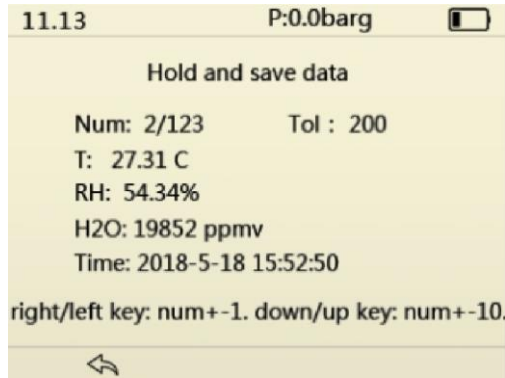

### 5.3 Display settings

In the display setting, you can select parameters. The temperature T is permanently selected and cannot be deselected. You can select or deselect all other parameters as you wish with the enter key.

**Attention:** You can select a maximum of two parameters. If you want to select a new parameter, you must first remove the other parameter.

The parameters can also be changed with the on/off key or the hold key. (For T d/f - dew point, for example, you can switch between Fahrenheit and Celsius).



## 5.4 Environmental parameters/ measurement settings

Can be selected to adjust the ambient pressure P of the probe and the molar mass of the gas measured in the probe.



### 5.4.1 Setting the probe pressure

Here you can set the pressure value P of the measured gas and the corresponding unit bara, barg, psia or psig. Change the value and select the unit by pressing the arrow up or down keys.

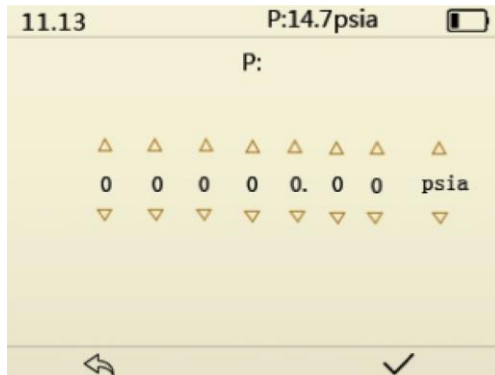

### 5.4.2 Adjust molar mass

The molar mass of air is 28.96 g/mol, and the molar mass of SF<sub>6</sub> gas is 146.05 g/mol. When measuring SF<sub>6</sub> gas, for example, ppmw M must be set to 146.05 g/mol. Change the value and select the unit by pressing the arrow up or down keys.



### 5.4.3 Cleaning

Select the "Cleaning" option and press the enter key. The probe will perform the cleaning and heat the sensor. The process takes about five to ten minutes.

### 5.5 Further settings

1 Language setting: Chinese and English.

2 Automatic power-off: off, 10 min, 15 min, 20 min, 25 min, 30 min

3 Brightness: Press the enter key to change the value. 10 different brightness levels can be selected.



Set the time and date, increase or decrease the number with the up or down keys and confirm your entry with the enter key.



The key sound can be enabled or disabled.

## 6 Warranty

You can read our warranty terms in our General Business Terms which you can find here: <https://www.pce-instruments.com/english/terms>.

## 7 Disposal

For the disposal of batteries in the EU, the 2006/66/EC directive of the European Parliament applies. Due to the contained pollutants, batteries must not be disposed of as household waste. They must be given to collection points designed for that purpose.

In order to comply with the EU directive 2012/19/EU we take our devices back. We either re-use them or give them to a recycling company which disposes of the devices in line with law.

For countries outside the EU, batteries and devices should be disposed of in accordance with your local waste regulations.

If you have any questions, please contact PCE Instruments.



## PCE Instruments contact information

### Germany

PCE Deutschland GmbH  
Im Langel 4  
D-59872 Meschede  
Deutschland  
Tel.: +49 (0) 2903 976 99 0  
Fax: +49 (0) 2903 976 99 29  
info@pce-instruments.com  
www.pce-instruments.com/deutsch

### United Kingdom

PCE Instruments UK Ltd  
Unit 11 Southpoint Business Park  
Ensign Way, Southampton  
Hampshire  
United Kingdom, SO31 4RF  
Tel: +44 (0) 2380 98703 0  
Fax: +44 (0) 2380 98703 9  
info@pce-instruments.co.uk  
www.pce-instruments.com/english

### The Netherlands

PCE Brookhuis B.V.  
Institutenweg 15  
7521 PH Enschede  
Nederland  
Telefoon: +31 (0)53 737 01 92  
info@pcebenelux.nl  
www.pce-instruments.com/dutch

### United States of America

PCE Americas Inc.  
1201 Jupiter Park Drive, Suite 8  
Jupiter / Palm Beach  
33458 FL  
USA  
Tel: +1 (561) 320-9162  
Fax: +1 (561) 320-9176  
info@pce-americas.com  
www.pce-instruments.com/us

### France

PCE Instruments France EURL  
23, rue de Strasbourg  
67250 Soultz-Sous-Forêts  
France  
Téléphone: +33 (0) 972 3537 17  
Numéro de fax: +33 (0) 972 3537 18  
info@pce-france.fr  
www.pce-instruments.com/french

### Italy

PCE Italia s.r.l.  
Via Pesciatina 878 / B-Interno 6  
55010 Loc. Gragnano  
Capannori (Lucca)  
Italia  
Telefono: +39 0583 975 114  
Fax: +39 0583 974 824  
info@pce-italia.it  
www.pce-instruments.com/italiano

### China

PCE (Beijing) Technology Co., Limited  
1519 Room, 6 Building  
Zhong Ang Times Plaza  
No. 9 Mentougou Road, Tou Gou District  
102300 Beijing, China  
Tel: +86 (10) 8893 9660  
info@pce-instruments.cn  
www.pce-instruments.cn

### Spain

PCE Ibérica S.L.  
Calle Mayor, 53  
02500 Tobarra (Albacete)  
España  
Tel. : +34 967 543 548  
Fax: +34 967 543 542  
info@pce-iberica.es  
www.pce-instruments.com/espanol

### Turkey

PCE Teknik Cihazları Ltd.Şti.  
Halkalı Merkez Mah.  
Pehlivan Sok. No.6/C  
34303 Küçükçekmece - İstanbul  
Türkiye  
Tel: 0212 471 11 47  
Faks: 0212 705 53 93  
info@pce- cihazlari.com.tr  
www.pce-instruments.com/turkish

### Hong Kong

PCE Instruments HK Ltd.  
Unit J, 21/F., COS Centre  
56 Tsun Yip Street  
Kwun Tong  
Kowloon, Hong Kong  
Tel: +852-301-84912  
jyi@pce-instruments.com  
www.pce-instruments.cn