

PCE Americas Inc.
711 Commerce Way
Suite 8
Jupiter
FL-33458
USA

From outside US: +1
Tel: (561) 320-9162
Fax: (561) 320-9176
info@pce-americas.com

PCE Instruments UK Ltd.
Units 12/13
Southpoint Business Park
Ensign way
Hampshire / Southampton
United Kingdom, SO31 4RF
From outside UK: +44
Tel: (0) 2380 98703 0
Fax: (0) 2380 98703 9
info@pce-instruments.com

www.pce-instruments.com/english
www.pce-instruments.com

OPERATING MANUAL

HVAC Meter

PCE- PCM 1

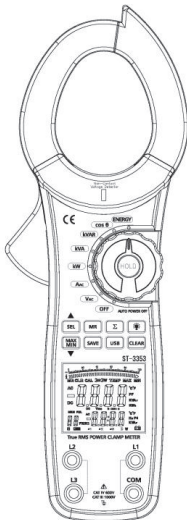

Overview

This Operating Manual covers information on safety and cautions. Please read the relevant information carefully and observe all the **Warnings** and **Notes** strictly.

Warning

To avoid electric shock or personal injury, read the “Safety Information” and “Rules for Safe Operation” carefully before using the Meter.

This clamp is a three phase intelligent handheld digital power clamp meter (hereafter referred to as “the Meter”) which has both the features of digital current meter and also power measurement meter.

The Meter can measure Voltage, Current, Active Power, Apparent Power, Reactive Power, Power Factor, Phase Angle, Frequency, Active Energy and etc.

Unpacking Inspection

Open the package case and take out the Meter. Check the following items carefully to see any missing or damaged part:

Item	Description	Qty
1	English Operating Manual	1 piece
2	Red Test Lead	3 piece
3	Black Test Lead	1 piece
4	Red Alligator Clip	3 piece
5	Black Alligator Clip	1 piece
6	USB Interface Cable	1 piece
7	Software	1 piece
8	Tool Box	1 piece
9	9V Battery	1 piece

In the event you find any missing or damage, please contact your dealer immediately.

Safety Information

This Meter complies with the standards IEC61010: in pollution degree 2, overvoltage category (CAT. III 600V, CAT IV 300V) and double insulation.

CAT. III: Distribution level, fixed installation, with smaller transient overvoltages than CAT. IV
CAT.IV: Primary supply level, overhead lines, cable systems etc.

Use the Meter only as specified in this operating manual, otherwise the protection provided by the Meter may be impaired.

In this manual, a **Warning** identifies conditions and actions that pose hazards to the user, or may damage the Meter or the equipment under test.

A **Note** identifies the information that user should pay attention to.

Rules For Safe Operation

Warning

To avoid possible electric shock or personal injury, and to avoid possible damage to the Meter or to the equipment under test, adhere to the following rules:

- Before using the Meter inspect the case. Do not use the Meter if it is damaged or the case (or part of

the case) is removed. Look for cracks or missing plastic. Pay attention to the insulation around the connectors.

- Inspect the test leads for damaged insulation or exposed metal. Replace damaged test leads with identical model number or electrical specifications before using the Meter.
- Do not apply more than the rated voltage, as marked on the Meter.
- When measurement has been completed, disconnect the connection between the test leads and the circuit under test, remove the test leads away from the input terminals of the Meter and turn the Meter power off.
- Do not carry out the measurement when the Meter's back case and / or battery door is opened to avoid electric shock.
- When the Meter working at an effective voltage over 30V in AC, special care should be taken.
- Use the proper terminals and function you're your measurements.
- Do not use or store the Meter in an environment of high temperature, humidity, explosive, inflammable and strong magnetic field. The performance of the Meter may deteriorate after dampened.
- Do not use the Meter if the surface of it is wet or the user's hands are wet.
- When using the test leads, keep your fingers behind the finger guards.

- Replace the battery as soon as the battery indicator  appears. With a low battery, the Meter might produce false readings that can lead to electric shock and personal injury.
- When opening the battery door, must make sure the Meter is power off.
- When servicing the Meter, use only the same model number or identical electrical specifications replacement parts.
- The internal circuit of the Meter shall not be altered at will to avoid damage of the Meter and any accident.
- Soft cloth and mild detergent should be used to clean the surface of the Meter when servicing. No abrasive and solvent should be used to prevent the surface of the Meter from corrosion, damage and accident.
- The Meter is suitable for indoor use.
- Turn the Meter off when it is not in use and take out the battery when not using for a long time.
- Constantly check the battery as it may leak when it has been using for some time, replace the battery as soon as leaking appears. A leaking battery will damage the Meter.

The Meter Structure

A. The Meter Front Structure (see figure 1)

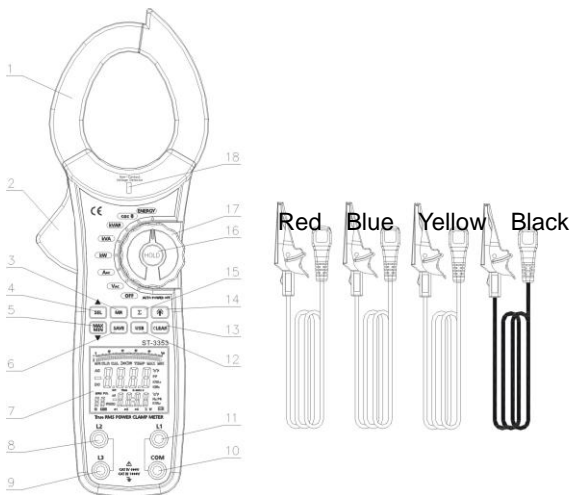

Figure 1

1	Transformer Jaw: designed to pick up the AC and DC current flowing through the conductor. It could transfer current to voltage. The tested conductor must vertically go through the Jaw center.
2	Hand Guards: to protect user's hand from touching the dangerous area.
3	MR button (recall data)
4	SEL / ▲ button (press to select phase and sum of Watts measurement)
5	MAXMIN / ▼ button
6	SAVE button (data store button)
7	LCD Display
8	L2 Input Terminal(Second phase measurement)
9	L3 Input Terminal (Third phase measurement)
10	COM Input Terminal
11	L1 Input Terminal (First phase measurement)

12	USB button
13	CLEAR button
14	LIGHT button (auto display backlight button)
15	Σ button (Sum)
16	HOLD button
17	Rotary function switch
18	NCV indicate lamp

B. The Meter Back and Bottom Structure

(see figure 2)

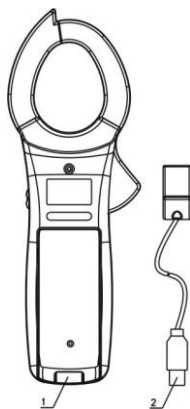





Figure 2

1	Infrared slot
2	USB Interface Cable

FUNCTION

Below table indicated for information about the functional button operations.

Button	Operation Performed
HOLD	<ul style="list-style-type: none"> ● Press HOLD to enter the Hold mode any mode,  appears and the Meter beeps. ● Press HOLD again to exit the Hold mode to return to measurement mode, the Meter beeps and,  disappears.
	Press the backlight button when needed. Auto shut-down backlight after lighting 20secs. Press the button again, turn the backlight off manually
Σ	<ul style="list-style-type: none"> ● At Active power (main display) + Phase angle (secondary display) mode, press Σ once button to sum up

	<p>the current phase of 3 phase measurement result. Then carry out second phase power measurement.</p> <ul style="list-style-type: none"> ● Press Σ and hold for over 1 second to sum up the phase power measurement result which had been selected. ● if you didn't select any phase of 3 phase, Σ is invalid.
SAVE	<ul style="list-style-type: none"> ● Press once to store single reading, and the Meter beeps. The index number shown on the left secondary display keep on increasing. The maximum number of data store is 99, when it achieves 99, the Meter shows FUL.
SEL	<ul style="list-style-type: none"> ● press SEL button to step through first phase, second phase, third phase and sum of watts. ● Press SEL and hold for over 2 second to enter 3P3W mode.
MAXMIN	<p>Press to start recording of maximum it valid at voltage, current, active power</p>

	and apparent power ranges only.
CLEAR	<ul style="list-style-type: none"> ● At active energy range, press CLEAR and hold for over 1 second to reset time the zero, then restart the timing. ● At all other ranges, press CLEAR and hold for over 1 second to clear stored readings.
MR	Press once to enter Memory Record mode, MIR appears and the Meter beeps.
▼/▲	<ul style="list-style-type: none"> ● If the Meter steps through sum of power press ▼/▲ button to switch display of active power (main display) , sum of reactive power (secondary display) , sum of power factor (main display) and sum of apparent power. ● In the MR mode, press ▼/▲ to select recorded data.
USB	Measurement data will be sent to the PC

1. Turn the rotary switch deasil to make the position away from the OFF position. Hearing a beep sound indicates the meter is turned on. The LCD displays all symbols firstly and then return to the normal mode. If the symbol  is displayed, please changed the battery.
2. After auto-shut-off, there are some parts of the circuit of the meter which is still work. If no measurement needed in a longer time, you'd better turn the rotary switch back to the OFF position.
3. Press the backlight button when needed. Auto shut-down backlight after lighting 18secs.Press the button again, turn the backlight off manually

Display Symbols (see figure 3)

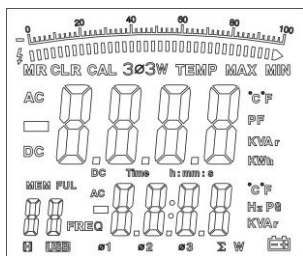











Figure 3

USB	Data Output is in progress
	First phase symbol
	Second phase symbol
	Third phase symbol
h	Unit for hour
mm	Unit for minute
HZ PG KVAr	Hz: Hertz. The unit of frequency. PG: The unit of phase angle KVAr. The unit of reactive power
ΣW	Watt: Sum of Watt
	The battery is low. ⚠ Warning: To avoid false readings, which could lead to possible electric shock or personal injury, replace the battery as soon as the battery indicator appears.
S	Unit for second

MAX MIN	Maximum and Minimum reading
	Analogue Bar Graph
	Overloading
	Ruler
CLEAR	Indicator for clear the stored reading
	Negative symbol
	High voltage symbol
AC	Indicator for AC voltage or current
MR	Indicator for recall the stored reading
Hz	Frequency symbol
MEM	Indicator for data store
FUL	Indicator for data stored is full
	Data hold is active

Measurement Operation

Preparation

- Dial the Rotary to any active measure range
- Replace the battery as soon as the battery indicator



appears on the display.

● Non-Contact Voltage Detector

WARNING: Risk of Electrocution. Before use, always test the Voltage Detector on a known live circuit to verify proper operation.

1. Rotate the Function switch to any measurement position.
2. Place the detector probe tip on the conductor to be tested.

NOTE: The conductors in electrical cord sets are often twisted. For best results, move the probe tip along a length of the cord to assure placing the tip close to the live conductor.

NOTE: The detector is designed with high sensitivity. Static electricity or other sources of energy may randomly trip the sensor. This is normal operation.

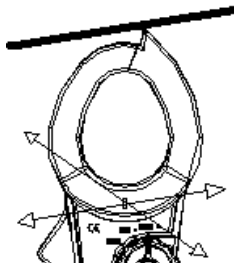

A. AC Voltage (main display) + Frequency (secondary display) Measurement (see figure 4)

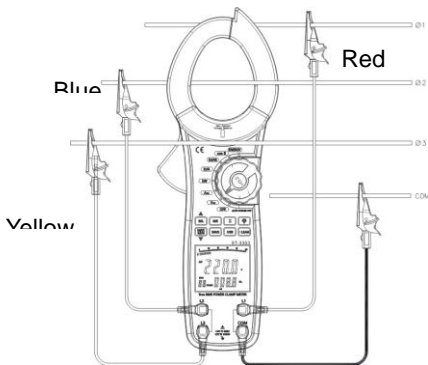

Figure 4

The AC Voltage ranges are:100V, 400V and 750V

The frequency range is:50Hz~60Hz

To measure AC voltage + frequency, connect the

Meter as follows:

1. Insert the red test lead into the **L1, L2, L3** input terminal, and black test lead to the **COM** input terminal.
2. Dial the Rotary to VAC to select Voltage + Frequency range.
3. Connect the red test leads (**L1, L2, L3** input terminal)to the corresponding three phases loaded live wire. Black test lead (**COM** input terminal) to the corresponding three phases loaded neutral wire.

4. Press **SEL** to select phase location, the display shows the corresponding phase symbol. **L1** means the first phase ϕ_1 , **L2** means the second phase ϕ_2 , **L3** means the third phase ϕ_3 .
5. The display shows the corresponding True RMS voltage value and frequency value of each phase.
6. Press **MAXMIN**, the LCD displays **MAX**, it starts recording the maximum AC voltage True RMS value.
7. Press **MAXMIN** the LCD displays **MIN**, it starts recording the minimum AC voltage True RMS value. Press **MAXMIN** again to show the current AC voltage True RMS value.
8. The display shows **OL** when the input voltage is higher than 750V rms.

Note

When the measurement has been completed, disconnect the connection between the testing leads and the circuit under test and remove testing leads from the input terminals.

B. AC Current (main display) + AC Voltage (secondary display) Measurement (see figure 5)

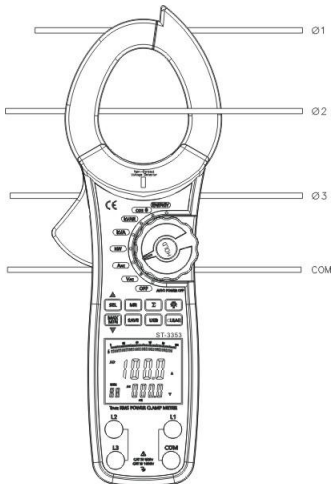

Figure 5

The AC current ranges are: 40A, 100A, 400A and 1000A

The AC Voltage ranges are: 100V, 400V and 750V

To measure AC current + AC voltage, connect the Meter as follows:

1. Dial the Rotary to AAC to select AC Current + AC Voltage range.

2. Press the lever to open the transformer jaw.
3. Center the conductor within the transformer jaw, then release the Meter slowly until the transformer jaw is completely closed, Make sure the conductor to be tested is placed at the center of the transformer jaw, otherwise it will cause deviation. The Meter can only measure one conductor at a time, to measure more than one conductor at a time will cause deviation.
4. The double display shows the AC current True RMS value and AC voltage True RMS value.
5. Press **MAXMIN**, the LCD displays **MAX**, it starts recording the maximum AC current True RMS value.
6. Press **MAXMIN**, the LCD displays **MIN**, it starts recording the minimum AC current True RMS value. Press **MAXMIN**, again to show the present AC current True RMS value.
7. The display shows **OL** when the current of the tested conductor is higher than 1000A rms.

Note

When the measurement has been completed, disconnect the connection between the conductor under test and the jaw, and remove the conductor away from the transformer jaw of the Meter.

C. Active Power (main display) + Phase Angle (secondary display) Measurement

Warning

To avoid damages to the Meter or harms to you, do you measure higher than AC voltage 750 v and AC current 1000A.

To measure active power + phase angle, connect the Meter as follows:

1. Diar the Rotary to KW to select Active power + Phase angle range.
 2. Press the lever to open the transformer jaw, and clamp them to the corresponding phase of tested conductor. If user needs to mesaure any phase of the 3 phase, then clamp them to that phase's conductor.
 3. Connecting method (see figure 6, 7, 8):
 4. Insert red test leads to **L1, L2, L3** input terminal and connecting it to every live wire of the 3 phase.
 5. Insert black test leads to **COM** input terminal and connect it to the neutrual wire of the 3 phase.
- When measuring 3 phase 4 wires, connecting the Meter as figure 6.

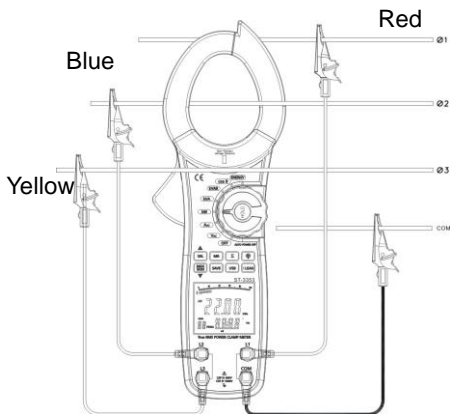

Figure 6

Measuring instruction

1. Press **SEL** to choose first phase 01, see figure 7. The double displays show the active power kW value and the PG value of the second phase 1.

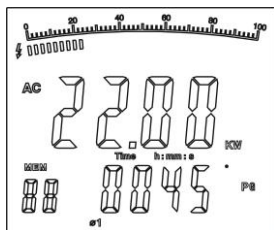

Figure 7

If necessary, press Σ to get the sum of watts as figure 8.

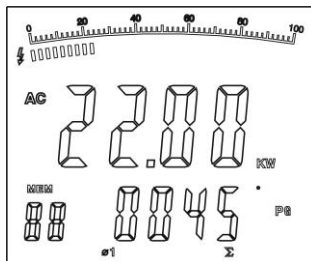

Figure 8

2. After record the current power measurement value of the first phase, then press **SEL** to choose $\text{Ø}2$, The double display shows the value of acitve power kW and PG of the second phase **2**. as figure 9

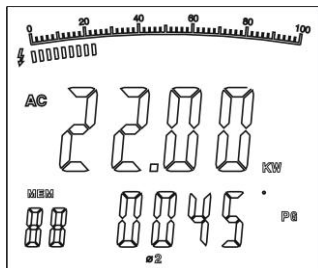

Figure 9

If necessary, press Σ to get the sum of watts as figure 10.

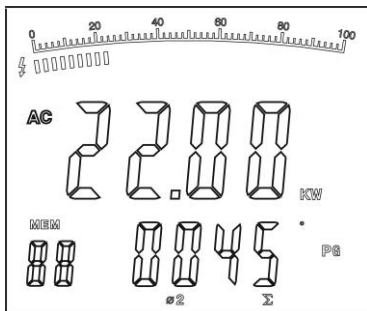

Figure 10

3. After record the current power measurement value of the second phase, then press **SEL** again to choose $\text{Ø}3$, The double display shows the value of active power KW and PG of the third phase. as figure 11.

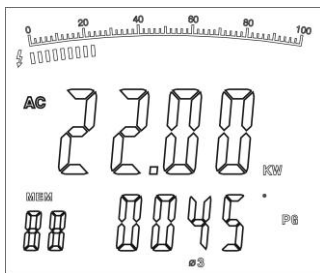

Figure 11

If necessary, press Σ to get the sum of watts as figure 12

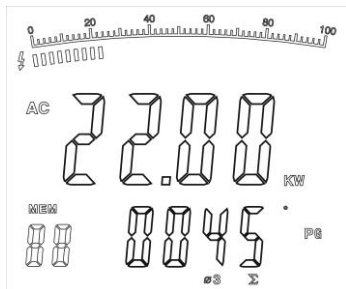

Figure 12

4. After record the current power measurement value of the third phase, finally press Σ and hold for 1seconds to display the 3 phase sum of acitve power value and apparent power value, as figure 13.

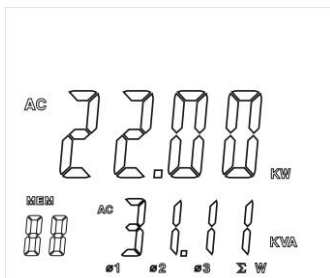

Figure 13

Press \blacktriangle as figure 14 to step through in sequence three

phase sum of active power+three phase sum of reactive power, and three phase sum of power factor + 3 phase sum of apparent power.

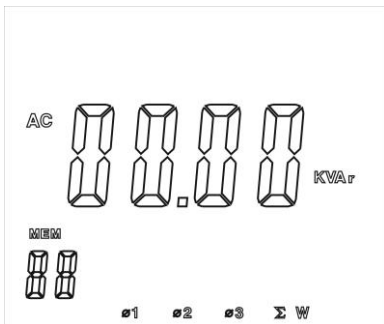

Figure 14

Press Σ and hold for 1seconds again back to the normal measuring mode.

In figure 6 $\Sigma W = W1 + W2 + W3$.

- When measuring 3 phase 3 wires, Hold **SEL** for 5 seconds and the Meter show **303W**, press **SEL** again for 5 seconds to exit 3 phase 3 wires ,connecting the Meter as figure 15.

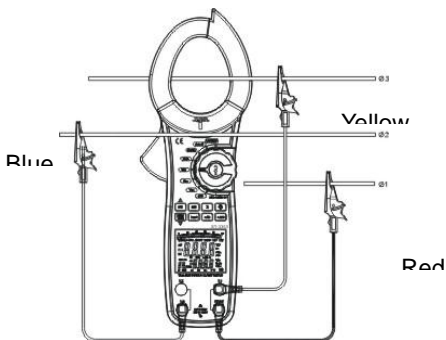

Figure 15

1. Insert red test leads to **L1, L3** input terminal.
2. Insert black test leads to **COM** input terminal and connect it to the neutral wire of the 3 phase.
3. Jump over the second phase measurement.
4. The first and the third phase measuring method is same as 3 phase 4 wires.

In figure 15 $\Sigma W = W2 + W3$.

NOTE

- It can only sum up the current measurement value. The maximum and minimum value cannot be summed up.
- Only at **KW** range can carry out sum of watts measurement, other ranges cannot carry out this measurement.
- When testing has been completed, disconnect the connection between the testing leads and the circuit under test and remove testing leads from the input terminals.

D. Apparent Power (main display) + Reactive Power

(secondary display) Measurement

- Please refer to **C**

E. Reactive Power (main display) + Apparent Power

(secondary display) Measurement

- Please refer to **C**.

F. Power Factor (main display) + Phase Angle

(secondary display) Measurement

Warning

To avoid damages to the Meter or harms to you, do you measure higher than AC voltage 750V rms and AC current 1000A rms.

To test for Power factor (main display) + Phase angle (secondary display), connect the Meter as follows:

1. Dial the Rotary to **cos θ** to select Power factor + Phase angle range.
2. Press the lever to open the transformer jaw, and clamp them to the corresponding phase of tested conductor. If user needs to measure any phase of the 3 phase, then clamp them to that phase's conductor.
3. The connecting method of 3 phases 4 wires or 3 phases 3 wires, refer to figure 6 and 15
4. When measuring 3 phase 4 wires: (see figure 18, 19 and 20)
 - Press **SEL** to choose the first phase , see figure 18.

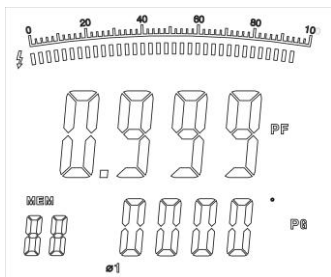

Figure 18

The double display shows the first phase value of power factor PF and phase angle PG.

Then press **SEL** again to choose the second phase, see figure 19.

- Press **SEL** to choose the second phase , see figure 19.

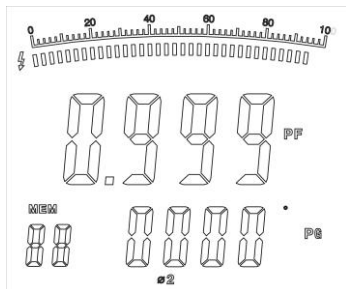

Figure 19

The double display shows the second phase value of

power factor PF and phase angle PG.

Then press **SEL** again to choose the third phase, see figure 20.

- Press **SEL** to choose the third phase , see figure 20.

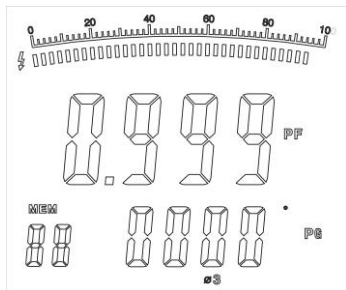

Figure 20

5. When measuring 3 phase 3 wires:

- The first phase and third phase operating method is same as 3 phase 4 wires.
 - Jump over the second phase measurement.
6. MAXMIN button are not valid when measuring power factor.

F. Active Energy (main display) + Time (secondary display) Measurement

Warning

To avoid damages to the Meter or harms to you, do you measure higher than AC voltage 750V rms and AC current 1000A rms.

To test for Active Energy (main display) + Time (secondary display), connect the Meter as follows:

1. Dial Rotary to **ENERGY** range.
2. Press the lever to open the transformer jaw, and clamp them to the corresponding phase of tested conductor. If user needs to measure any phase of the 3 phase, then clamp them to that phase's conductor.
3. The connecting method of 3 phase 4 wires and 3 phases 3 wires, see figure 6 and 15
4. Press **SEL** to choose one of the three phases, see figure 21.

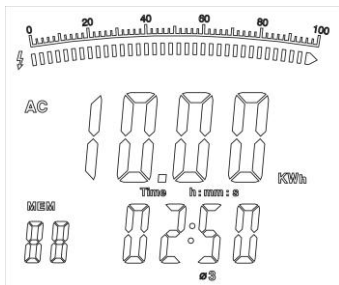

Figure 21

- The double display shows the value of tested object's active energy kWh value and the measuring time of the corresponding phase.
- The measuring reading gets increasing along with the time increases. Press **HOLD** to read a particular time kWh value. Then the reading and time are locked, but still continuous accumulate measuring time.
- After read the data, press **HOLD** again to continuous measurement. kWh value continuous accumulate and the measuring time jumps to the present measuring time.

- When the measuring time is over 24 hours or the Meter is switched to other measuring ranges, active energy measuring will stop.

- The maximum reading of active energy is 9999kWh. **OL** will be displayed when the reading is over than that.

5. **MAXMIN** are not valid when measuring active energy.

6. Press **CLEAR** and hold for 1 seconds to reset the time and energy.

Note

- When there is no input signal, it cannot carry out active energy measurement.

- When testing has been completed, disconnect the connection between the testing leads and the circuit under test and remove testing leads from the input terminals.

True RMS Measurement and Average Value Measurement

The True RMS measurement method can measure accurately the effective value of non-sine wave input signal.







Average value measurement method can measure the mean value of one sine wave input signal, and then displays it as RMS value

When the input waveform has distortion, measuring tolerance will be included. The total tolerance depends on the total distortion. Below table 1 shows the waveform coefficient and the relationship and the requested changing factor of sine wave, square wave,

pulse rectangle wave, sawtooth triangle wave, RMS value and average value.

The clamp Meter software designing base on the following formula:

- $KW = KVA \times \cos\theta$
- $KVAr = \frac{KVA \times \sin\theta}{1}$
- $KVA = \sqrt{KW^2 + KVAr^2}$

Input Wave	PK-PK	0-PK	RMS	AVG
Sine 	2.828	1.414	1.000	0.900
sine commute (whole wave) 	1.414	1.414	1.000	0.900
sine commute (half wave) 	2.828	2.828	1.414	0.900
square wave 	1.800	0.900	0.900	0.900
commuted square wave 	1.800	1.800	1.272	0.900
pulse rectangle $D=X/Y$ 	0.9/D	0.9/ D	0.9D/2	0.9/D
sawtooth triangle 	3.600	1.800	1.038	0.900

Accurate Specifications

Accuracy: (a% reading + b digits), guarantee for 1 year.

Operating temperature: 23°C±5°C

Operating humidity: 45~75%R.H

A. AC Voltage (True RMS)

Range	Resolution	Accuracy	Allowable Maximum overload protection voltage	Input Impedance	Frequency Range
100V	0.1V	± (1.2%+5)	750 RMS	10M	50Hz~200 Hz
400V					
750V					

B. Frequency

Range	Resolution	Accuracy
50Hz~200Hz	1Hz	± (0.5%+5)

C. AC Current (True RMS)

Range	Resolution	Accuracy	Allowable Maximum overload protection current	Frequency Range
40A	0.1A	$\pm(2\%+5)$	1000A RMS	50Hz~60Hz
100A				
400A				
1000A	1A			

D. Active Power ($W=V \times A \times \text{COS } \theta$)

Current / Voltage		Voltages Range		
		100V	400V	750V
Current Range	40A	4.00KW	16.00KW	30.00KW
	100A	10.00KW	40.00KW	75.00KW
	400A	40.00KW	160.0KW	300.0KW
	1000A	100.0KW	400.0KW	750.0KW
Accuracy		$\pm(3\%+5)$		
Resolution		<1000KW: 0.01KW 100kW: 0.1KW		

E. Apparent Power ($VA = V \times A$)

Current / Voltage		Voltages Range		
		100V	400V	750V
Current Range	40A	4.00KVA	16.00KVA	30.00KVA
	100A	10.00KVA	40.00KVA	75.00KVA
	400A	40.00KVA	160.0KVA	300.0KVA
	1000A	100.0KVA	400.0KVA	750.0KVA
Accuracy		$\pm(3\%+5)$		
Resolution		<1000KVA: 0.01KVA 100kW: 0.1KVA		

F. Reactive Power (Var = V x A x SIN θ)

Current / Voltage		Voltages Range		
		100V	400V	750V
Current Range	40A	4.00KVAr	16.00KVAr	30.00KVAr
	100A	10.00KVAr	40.00KVA	75.00KVAr
	400A	40.00KVAr	160.0KVAr	300.0KVAr
	1000A	100.0KVAr	400.0KVAr	750.0KVAr
Accuracy		$\pm(3\%+5)$		
Resolution		<1000KVAr: 0.01KVAr 100kW: 0.1KVAr		

G. Power Factor (PF = W / VA)

Range	Accuracy	Resolution	Measuring Condition
0.3~1 (capacitive or inductive)	± 0.022	0.001	The minimum measuring current 10A The minimum measuring voltage 45V
0.3~1 (capacitive or inductive)	For reference only		Measuring current less than 10A OR Measuring voltage less than 45V

H. Phase Angle (PG=acos (PF))

Range	Accuracy	Resolution	Measuring Condition
0° ~90° (capacitive or inductive)	±2°	1°	The minimum measuring current 10A The minimum measuring voltage 45V
0° ~90° (capacitive or inductive)	For reference only		Measuring current less than 10A OR Measuring voltage less than 45V

I. Active Energy (kWh)

Range	Accuracy	Resolution
1~9999kWh	±(3%+2)	0.001kWh

Remarks:

- Allowable maximum overload protection voltage: 750V RMS
- Allowable maximum overload protection current: 1000A RMS

SPECIFICATIONS

Basic Functions	Range	Best Accuracy
AC Voltage	100V/400V/750V	$\pm(1.2\%+5\text{digits})$
AC Current	40A/100A/400A/1000A	$\pm(2\%+5\text{ digits})$
Active Power	0.01kW-750kW	$\pm(3\%+5\text{ digits})$
Apparent Power	0.01kVA-750kVA	$\pm(3\%+5\text{ digits})$
Reactive Power	0.01kVAr-750kVAr	$\pm(4\%+5\text{ digits})$
Power Factor	0.3~1(Capacitive or Inductive)	$\pm(0.02+2\text{ digits})$
Phase Angle	$0^{\circ} \sim 90^{\circ}$	$\pm 2^{\circ}$
Frequency	50Hz-200Hz	√
Active Energy	0.001~9999 kWh	$\pm(3\%+2\text{ digits})$
Temperature	-50°C~1300°C -58°F~2372°F	
Special Functions		
Auto Ranging		√
Single-phase 2-wire		√
Balance 3-phase 3-wire		√

3-phase 4-wire		✓
True RMS	AC Voltage or Curren	✓
Data Logging	99	✓
Data Recall		✓
Max/Min Mode		✓
Data Hold		✓
USB		✓
Display Backlight		✓
Full Icon Display		✓
Sleep Mode		✓
Low Battery Display		✓
Input Impedance for AC Voltage Measurement	Around 10MW	✓
Max. Display	9999	✓
Analogue Bar Graph		✓

