



User Manual

PCE-PIC 20 / 40 Drain Camera



User manuals in various languages (français, italiano, español, português, nederlands, türk, polski, русский, 中文) can be found by using our product search on: www.pce-instruments.com

Last change: 12 October 2020
v1.0



Contents

1	Safety notes	1
2	Specifications	3
3	Delivery scope	3
4	Device description	4
4.1	Key assignment	5
4.2	Camera head description	6
4.3	Cable reel	6
4.4	Control case	7
4.5	Display description	8
5	Change camera head	9
6	Guides	10
7	Storage medium	11
8	Switching on / off	11
9	Set video recording	12
10	Saved records	12
10.1	Play video	12
10.2	Records menu	13
11	General settings	13
12	Wireless keyboard	13
12.1	Set header	14
13	Metre counter	14
14	Charging the battery	14
15	Troubleshooting	14
16	Warranty	15
17	Disposal	15

1 Safety notes

Please read this manual carefully and completely before you use the device for the first time. The device may only be used by qualified personnel and repaired by PCE Instruments personnel. Damage or injuries caused by non-observance of the manual are excluded from our liability and not covered by our warranty.

- The device must only be used as described in this instruction manual. If used otherwise, this can cause dangerous situations for the user and damage to the meter.
- The instrument may only be used if the environmental conditions (temperature, relative humidity, ...) are within the ranges stated in the technical specifications. Do not expose the device to extreme temperatures, direct sunlight, extreme humidity or moisture.
- Do not expose the device to shocks or strong vibrations.
- The case should only be opened by qualified PCE Instruments personnel.
- Never use the instrument when your hands are wet.
- You must not make any technical changes to the device.
- The appliance should only be cleaned with a damp cloth. Use only pH-neutral cleaner, no abrasives or solvents.
- The device must only be used with accessories from PCE Instruments or equivalent.
- Before each use, inspect the case for visible damage. If any damage is visible, do not use the device.
- Do not use the instrument in explosive atmospheres.
- The measurement range as stated in the specifications must not be exceeded under any circumstances.
- Non-observance of the safety notes can cause damage to the device and injuries to the user.
- Both the camera head and the cable are waterproof. The control box is only waterproof once the case is closed. The case must therefore not come into contact with water when open.
- Back up all data on the SD card before using the storage medium with the drain camera.
- Always wear rubber gloves when working with the drain camera.
- The cable must not be subjected to excessive strain or bending. Otherwise the cable may break.
- Sharp edges can damage the cable.
- If the camera does not move any further, do not push the cable too hard in order not to damage it.
- Do not push objects with the camera in the pipe.

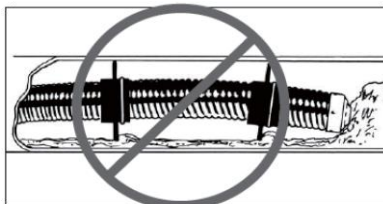

- Your hands should always be close to the pipe to be checked to prevent possible bending.
- To keep the system clean and to facilitate the insertion of the cable, water should always be fed into the pipe to be tested.
- Push the cable into the pipe slowly and evenly.
- Always keep the camera lens clean.



- When the camera is in a drain, heat can accumulate because the camera head heats up. This can lead to blurring. Therefore, allow the camera head to cool down for 10 ... 15 minutes.
- If the cable is pulled back in, this must be done evenly. Do not tear the cable as this could damage the camera.
- Both the cable and the camera may only be rewound when cleaned.
- When rolling up the cable, the hand must not be too far away from the reel, otherwise the cable could be bent.
- The battery must be charged once every 6 months at the latest.

We do not assume liability for printing errors or any other mistakes in this manual.

We expressly point to our general guarantee terms which can be found in our general terms of business.

If you have any questions please contact PCE Instruments. The contact details can be found at the end of this manual.

2 Specifications

Property	
Cable diameter / head diameter	23 mm
Cable length	PCE-PIC 20: 20 m PCE-PIC 40: 40 m
Field of view	20 ... 100 cm
Viewing angle	120 °
Lighting	12 x LED (dimnable)
White balance	Automatic
Image sensor	1/3" Sony CCD 720 x 576 pixels
Display	7" LC display
Interface	USB 2.0
Memory options	Video, image and sound
Image memory	SD card up to 32 GB
Video output format	PAL 720 x 576 pixels NTSC 720 x 488 pixels
Menu navigation	Multilingual: German, English, French, Spanish, Italian, Portuguese, Japanese, Chinese, Russian
Length measurement	0 ... 20 or 40 m
Data entry	Possible via keyboard
Operating conditions	-10 ... 50 °C / 30 ... 90 % RH
Storage conditions	-20 ... 60 °C / 30 ... 90 % RH
Power supply	Power supply 110 V ... 240 V AC / 12 V / 1.2 A DC Li Ion battery 7.4 V / 5400 mAh
Protection class	Display: IP66 Camera head: waterproof up to 20 m
Dimensions	complete: 55 x 43.5 x 34.5 cm camera head: 23 x 45 mm (total length: 150 mm)
Weight	approx. 13 kg

3 Delivery scope

- 1 x drain camera PCE-PIC series, 20 or 40 m length
- 1 x standard camera head
- 1 x main unit with case, cable reel and push cable
- 1 x mains adaptor
- 1 x car charging adaptor
- 1 x keyboard
- 1 x remote control
- 1 x 46 mm guide
- 1 x 80 mm guide
- 1 x user manual





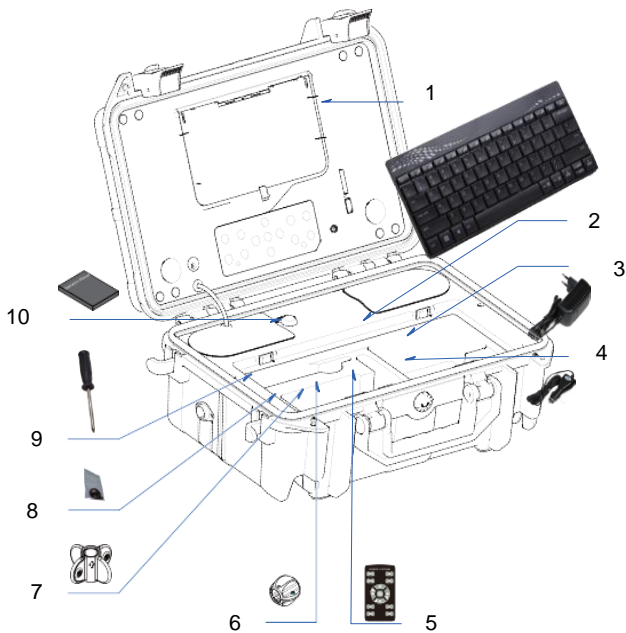



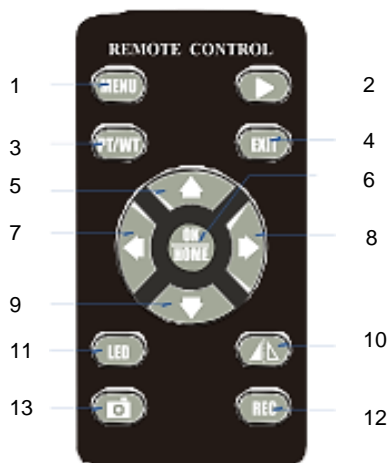



4 Device description

No.	Description
1	Display with sun visor
2	Wireless keyboard
3	Power supply (house connection)
4	Power supply (car)
5	Remote control
6	Guides
7	Assembly tool for guides
8	Sealing kit
9	Screwdriver
10	User manual



4.1 Key assignment



Symbol	No.	Description
	1	MENU key to open the menu
	2	This key allows you to view the saved videos and images and also to return to video mode.
	3	This key has no function.
	4	Use the EXIT key to go back one level.
	5	Arrow up key
	6	Enter key
	7	Arrow right key
	8	Arrow left key
	9	Arrow down key
	10	Press this key to rotate the displayed image.
	11	The LED key can be used to set the LED illuminance.
	12	Use the video recording key to start video recording.
	13	Use the image capture key to take a picture.

4.2 Camera head description

No.	Description
1	Connection thread with sealing ring
2	Stainless steel spring with internal surge protection
3	304# stainless steel housing
4	Lens with LED lighting

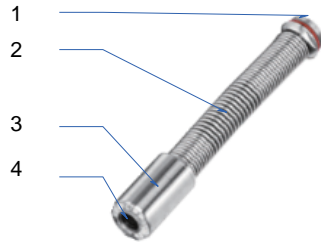

4.3 Cable reel

No.	Description
1	Frame
2	Receiver for the wireless keyboard
3	Metre counter reset (also in the case)
4	Plug connection for video transmission
5	Rolled up cable
6	Connection for the camera
7	Holder for the camera head for safe transport
8	Hook

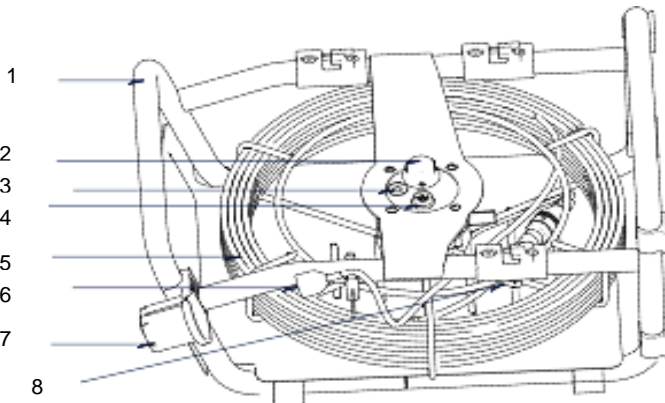

4.4 Control case

No.	Description
1	On / off key
2	USB port connection (service interface)
3	SD card slot
4	Colour display
5	Sun protection
6	Connection for power supply
7	Metre counter reset
8	Wireless keyboard
9	Connection to the cable drum

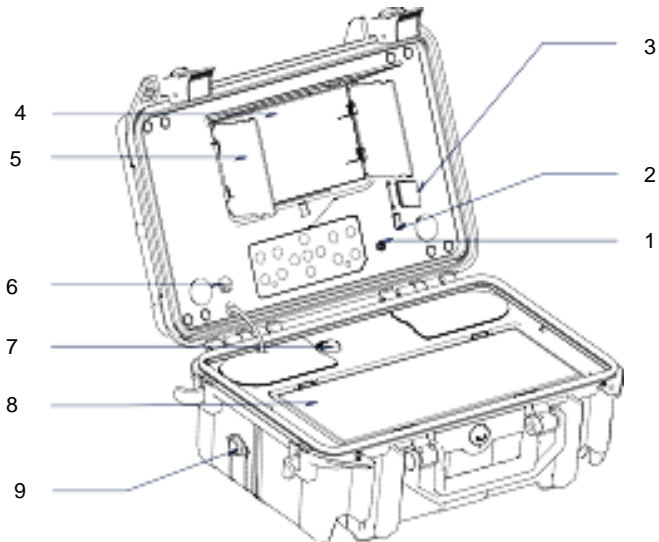

4.5 Display description

No.	Description
1	SD card recognised
2	Battery status indicator
3	The displayed image is rotated
4	The displayed image is rotated and mirrored
5	The displayed image is mirrored
6	Current time and date
7	Lighting intensity
8	Video recording started
9	Metre counter

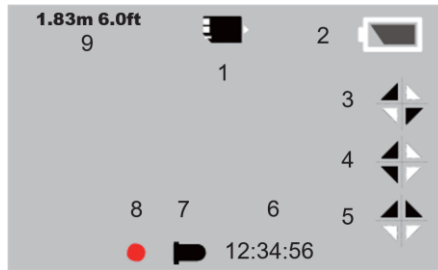

5 Change camera head

For the PCE-PIC series, different camera heads are available. To change the camera heads, the drain camera must first be switched off. Now you can unscrew the camera head as shown on the right. For the drain camera, the following camera heads are optionally available:

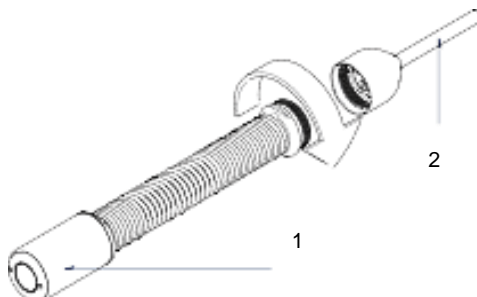

No.	Description
1	Camera head
2	Borescope tube

Item	Description
PCE-PIC-NCH	Standard replacement camera head
PCE-PIC-SCH	Self-levelling camera head
PCE-PIC-TCH	Camera head with transmitter for localisation (for localisation, the receiver PCE-VE-LOC is required)

6 Guides

There are guides to keep the camera head in the middle of a drain. These can be mounted directly to the front of the camera head. They can be mounted with two screws.

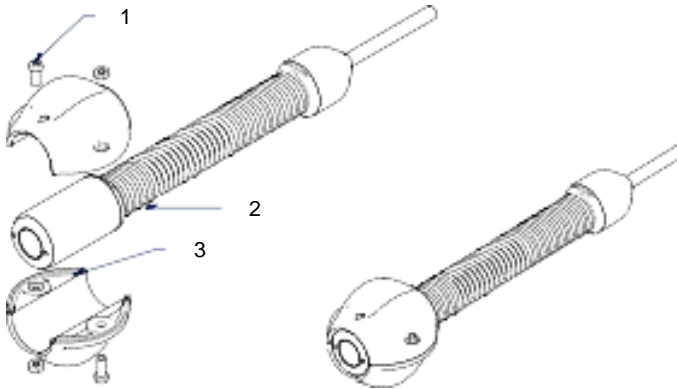

No.	Description
1	Fixing screws
2	Camera head
3	Guide

7 Storage medium

To install a storage device, insert, for example, an SD card into the slot provided.

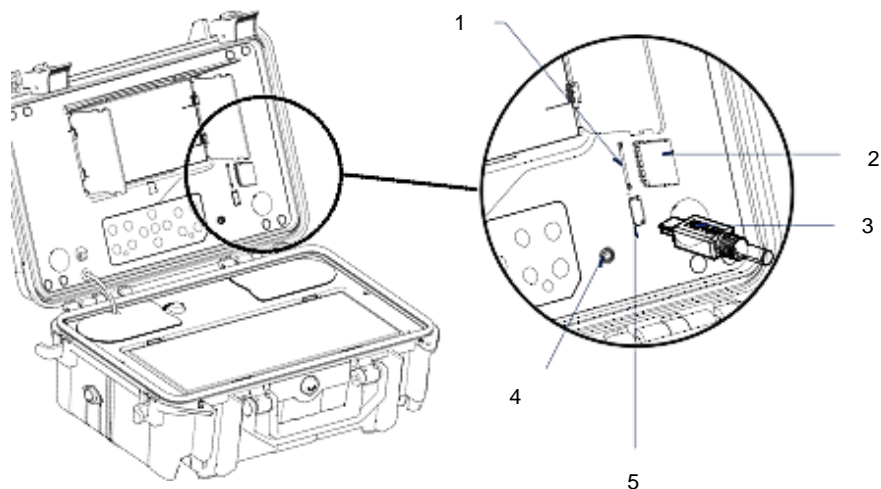

No.	Description
1	SD card slot
2	SD card
3	USB cable
4	On/off switch
5	USB port (service interface)



8 Switching on / off



To switch the drain camera on and off again, press the on/off switch briefly once. The drain camera will switch itself on / off directly.







9 Set video recording



To perform settings regarding video recording, press the  key during live view. To close the menu, press the  key. Use the arrow keys to select the desired function. Press the  key to open the desired function. You can now change parameters using the arrow keys, if necessary. The menu is structured as follows:

Function	Description
Size	You can set the resolution of the record. You can choose from HD (1280 x 720), VGA (640 x 480), QVGA (320 x 240), D1 (720 x 576)
Video Seg	Here you can set the maximum recording time. Possible settings: 10, 20, 30 40, OFF.
MeterCount	Here you can set the unit of the metre counter.
Sound	Here you can activate the microphone. The microphone is located in the case and not in the camera head.
Time Stamp	Here you can activate and deactivate the time-date stamp.





10 Saved records

To recall all saved records, once press and release the  key. Press the  key again to return to live view, if necessary.



You will see a list of all records. Use the arrow keys   to select the desired record. Press the  key to open the record. Use the  and  keys to return to list view. Now you can also select records in large view using the arrow keys  .

To obtain more information about the record, press and hold the  key once. Press the  key again to exit the view.

10.1 Play video





To play a video record, press the  key. To pause the recording, press the  key again. Press the  key to rewind. To fast forward again, press the  key. Press the  key to adjust the playing speed.

10.2 Records menu

The same menu is available for each record. You can open the menu both in list view and in large view by pressing the  key. To close the menu, press the  key. Use the arrow keys to select the desired function. Press the  key to open the desired function. If necessary, you can now change parameters with the arrow keys. The menu is structured as follows:

Function	Description
Delete	Allows you to delete a selected record
Slide Show	This allows you to view all records via an automatic slide show. You can choose between an interval of 3, 5 and 10 seconds.
Protect	To protect the record from being deleted, you can enable the protect function. You can choose whether to protect a single recording, an entire page or all recordings. To cancel the protection, select this function again.
Thumbnail	This function allows you to switch from list view to thumbnail view. This gives you a 3 x 3 image preview.
File List	This function allows you to switch from thumbnail view to list view. This displays the records in a list.
Volume	No function

11 General settings

To make settings in the drain camera, first press the  key. Now press the  key to go to the general settings. To close the menu again, press the  key. Use the arrow keys to select the desired function. Press the  key to open the desired function. If necessary, you can now change parameters with the arrow keys. The menu is structured as follows:

Function	Description
Format SD	Here you can format the inserted SD card.
LCD brightness	Here you set the brightness of the display.
Language	Here you can change the menu language. Available for selection: English, German, French, Spanish, Italian, Chinese, Japanese, Russian, Portuguese
Sys. Reset.	You can reset all settings here.
Light Freq.	Here you set the local mains frequency to prevent a flickering picture.
TV Output	Here you set the TV output signal.
Date Input	You can set the date and time.

12 Wireless keyboard

A total of 384 characters can be displayed on the live image. These can be typed in using the wireless keyboard. The cursor can be moved to any position with the arrow keys. With the "ESC" key, the indication can be hidden and shown again. With "CTRL + DEL" you can delete the entire view.

The characters can also be changed during recording.



12.1 Set header

To set the header, first hold down the "F1" key when the drain camera is switched off and switch it on. You can now set the header. Press the Enter key to confirm the setting.

You cannot hide this indication with the "ESC" key.

13 Metre counter

The drain camera has a metre counter for the cable used. The metres used are shown in the display. To reset this display, press the "Meter-Zero" key in the case.

14 Charging the battery

To charge the battery, use the AC adaptor supplied with the instrument. When using the car charging adaptor, make sure that the on-board voltage is 12 V. A red LED lights up during the charging process. When the LED is green, the battery is fully charged. If the LED flashes red, this indicates that the battery is being pre-charged. This happens if the battery has been discharged for a long period of time. This process takes about 10 minutes. The normal charging process then begins. A full charge takes about 8 hours. The drain camera can also be used during the normal charging process.

15 Troubleshooting

Error	Cause	Solution
Metre counter imprecise	Measuring wheel slips	Check the mounting of the measuring roller on the cable.
	Zero point not set	Reset the zero point.
	Wrong maximum length selected	When making settings in the drain camera, hold down the F2 key and change the set maximum length to the actual cable length.
No picture	Cable connection interrupted	Check the cable connections. Clean them if necessary and reconnect them.
	Camera connection contaminated	Clean the connections.
	Wrong SD card	Switch off the drain camera and replace the card.
	Incorrect settings	Go to the menu and check the settings. If necessary, reset the settings.
Display does not switch on	No voltage	Charge the batteries.
	Short-term short circuit	Charge the drain camera for more than 2 seconds to reset the fuse.
Keyboard without function	Batteries are discharged	Replace the batteries with new ones.
	Keyboard or receiver faulty	Check the keyboard on a PC.

16 Warranty

You can read our warranty terms in our General Business Terms which you can find here: <https://www.pce-instruments.com/english/terms>.

17 Disposal

For the disposal of batteries in the EU, the 2006/66/EC directive of the European Parliament applies. Due to the contained pollutants, batteries must not be disposed of as household waste. They must be given to collection points designed for that purpose.

In order to comply with the EU directive 2012/19/EU we take our devices back. We either re-use them or give them to a recycling company which disposes of the devices in line with law.

For countries outside the EU, batteries and devices should be disposed of in accordance with your local waste regulations.

If you have any questions, please contact PCE Instruments.





PCE Instruments contact information

Germany

PCE Deutschland GmbH
Im Langel 4
D-59872 Meschede
Deutschland
Tel.: +49 (0) 2903 976 99 0
Fax: +49 (0) 2903 976 99 29
info@pce-instruments.com
www.pce-instruments.com/deutsch

United Kingdom

PCE Instruments UK Ltd
Unit 11 Southpoint Business Park
Ensign Way, Southampton
Hampshire
United Kingdom, SO31 4RF
Tel: +44 (0) 2380 98703 0
Fax: +44 (0) 2380 98703 9
info@pce-instruments.co.uk
www.pce-instruments.com/english

The Netherlands

PCE Brookhuis B.V.
Institutenweg 15
7521 PH Enschede
Nederland
Telefoon: +31 (0)53 737 01 92
info@pcebenelux.nl
www.pce-instruments.com/dutch

United States of America

PCE Americas Inc.
1201 Jupiter Park Drive, Suite 8
Jupiter / Palm Beach
33458 FL
USA
Tel: +1 (561) 320-9162
Fax: +1 (561) 320-9176
info@pce-americas.com
www.pce-instruments.com/us

France

PCE Instruments France EURL
23, rue de Strasbourg
67250 Soultz-Sous-Forêts
France
Téléphone: +33 (0) 972 3537 17
Numéro de fax: +33 (0) 972 3537 18
info@pce-france.fr
www.pce-instruments.com/french

Italy

PCE Italia s.r.l.
Via Pesciatina 878 / B-Interno 6
55010 Loc. Gragnano
Capannori (Lucca)
Italia
Telefono: +39 0583 975 114
Fax: +39 0583 974 824
info@pce-italia.it
www.pce-instruments.com/italiano

China

PCE (Beijing) Technology Co., Limited
1519 Room, 6 Building
Zhong Ang Times Plaza
No. 9 Mentougou Road, Tou Gou District
102300 Beijing, China
Tel: +86 (10) 8893 9660
info@pce-instruments.cn
www.pce-instruments.cn

Spain

PCE Ibérica S.L.
Calle Mayor, 53
02500 Tobarra (Albacete)
España
Tel. : +34 967 543 548
Fax: +34 967 543 542
info@pce-iberica.es
www.pce-instruments.com/espanol

Turkey

PCE Teknik Cihazları Ltd.Şti.
Halkalı Merkez Mah.
Pehlivan Sok. No.6/C
34303 Küçükçekmece - İstanbul
Türkiye
Tel: 0212 471 11 47
Faks: 0212 705 53 93
info@pce- cihazlari.com.tr
www.pce-instruments.com/turkish

Hong Kong

PCE Instruments HK Ltd.
Unit J, 21/F., COS Centre
56 Tsun Yip Street
Kwun Tong
Kowloon, Hong Kong
Tel: +852-301-84912
jyi@pce-instruments.com
www.pce-instruments.cn