

*0.00 to 50.00 NTU, 50 to 1,000 NTU*

# **TURBIDITY METER**

**Model : TUM 20**



Your purchase of this TURBIDITY METER marks a step forward for you into the field of precision measurement. Although this CHLORINE METER is a complex and delicate instrument, its durable structure developed. Please read the following instructions carefully and always keep this manual within easy reach.

**OPERATION MANUAL**

# TABLE OF CONTENTS

1. FEATURES.....	1
2. SPECIFICATIONS.....	1
3. FRONT PANEL DESCRIPTION.....	3
3-1 Cover of Testing bottle.....	3
3-2 Container of Testing bottle.....	3
3-3 Display.....	3
3-4 Hold Button ( Esc Button ).....	3
3-5 TEST/CAL Button ( Enter Button ).....	3
3-6 Power Button.....	3
3-7 ZERO Button.....	3
3-8 REC Button ( MAX, MIN Button ).....	3
3-9 Testing bottle with 0 NTU standard solution.....	3
3-10 Testing bottle with 100 NTU standard solution.....	3
3-11 Empty testing bottle 1.....	3
3-12 Empty testing bottle 2.....	3
3-13 Battery Compartment/Cover.....	3
3-14 Clean Cloth.....	3
3-15 Clean Solution ( Distill Water ).....	3
4. MEASURING PROCEDURE.....	4
4-1 Measurement Consideration.....	4
4-2 Measurement.....	5
4-3 Zero.....	6
4-4 Data Hold.....	6
4-5 Data Record ( Max., Min. reading ).....	6
5. CALIBRATION PROCEDURE.....	7
6. CALIBRATION CLEAR.....	11
7. BATTERY REPLACEMENT.....	13

# 1. FEATURES

- \* Designed to meet ISO 7027.
- \* NTU ( Nephelometric TURBIDITY Unit ) measuring unit.
- \* Wide and auto measurement range : 0 to 1,000 NTU.
- \* High resolution : 0.01 NTU/1 NTU.
- \* The unique optics structure, enables the instrument to read low value of TURBIDITY to the high level up to 1,000 NTU.
- \* Four operation buttons and two calibration points, easy operation and guarantee the spec. accuracy.
- \* Jumbo LCD, easy readout.
- \* Microprocessor circuit assures maximum possible accuracy, provides special functions and features.
- \* Battery operated for field and on-site testing convenience.
- \* Data hold function for freezing the desired value on display.
- \* Records Maximum and Minimum readings with Recall.
- \* Heavy duty & compact housing with hard carrying case, designed for easy carry out & operation.
- \* Auto shut off is available to save battery life.
- \* Application : Test municipal water, food and beverage water, or other aqueous solution where fluid clarity is important.

# 2. SPECIFICATIONS

Circuit	Custom one-chip of microprocessor LSI circuit.
Display	LCD size : 41 mm x 34 mm.
Range	0.00 to 50.00 NTU, 50 to 1,000 NTU * <i>NTU : Nephelometric Turbidity Unit</i> * <i>Auto range</i>

Accuracy	$\pm 5 \% \text{ F.S. or } \pm 0.5 \text{ NTU, which ever is greater.}$	
Light source	LED, 850 nm.	
Detector	Photo diode	
Standard	Meet ISO 7027.	
Response time	Less than 10 seconds.	
Sample volume needed	10 mL.	
Data hold	Freeze the display reading.	
Memory recall	Maximum & Minimum value.	
Display sampling time	Approx. 1 second.	
Power off	Auto shut off saves battery life or manual off by push button.	
Calibration points	0 NTU, 100 NTU.	
Operating temperature and humidity	0 to 50 °C . Less than 85% R.H.	
Power supply	DC 1.5 V battery ( UM4, AAA ) x 6 PCs, or equivalent.	
Power current	Stand by	Approx. DC 3.5 mA.
	Testing	Approx. DC 36 mA.
Weight	320 g/0.70 LB. @ <i>Battery is included.</i>	
Dimension	155 x 76 x 62 mm ( 6.1 x 3.0 x 2.4 inch)	
Accessories Included	Instruction manual 1 PC. Testing bottle with 0 NTU standard, TU-0NTU..... 1 PC. Testing bottle with 100 NTU standard, TU-100NTU..... 1 PC. Empty testing bottle ( Bottle-061 )..... 2 PCs Clean cloth..... 1 PC. Clean solution ( Distill water )..... 1 bottle Hard carrying case, CA-08..... 1 PC.	
Optional Accessories	Testing bottle with 100 NTU standard solution, TU-100NTU Testing bottle with 0 NTU standard solution, TU-0NTU Empty testing bottle, 0601	

# 3. FRONT PANEL DESCRIPTION

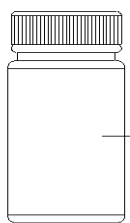
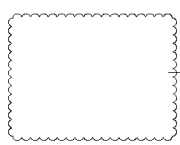
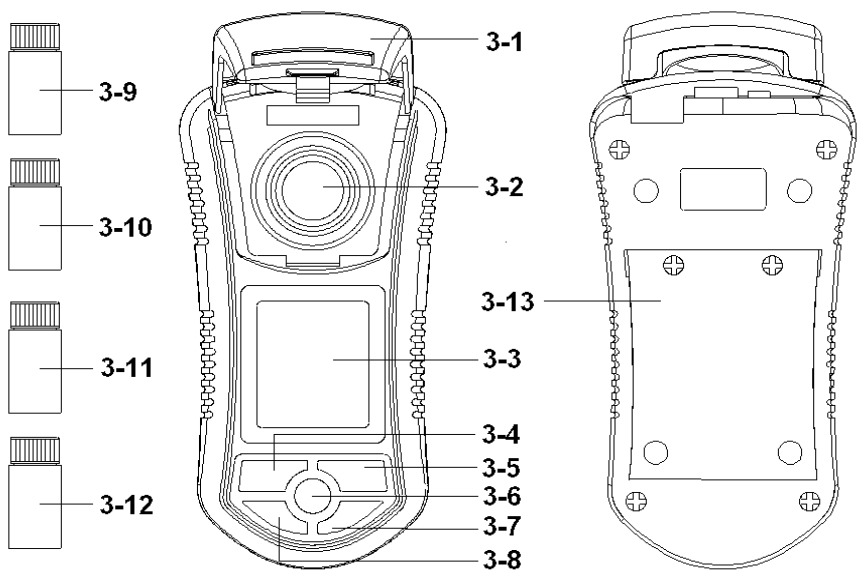

- 3-1 Cover of Testing bottle
- 3-2 Container of Testing bottle
- 3-3 Display
- 3-4 Hold Button ( Esc Button )
- 3-5 TEST/CAL Button
- 3-6 Power Button
- 3-7 ZERO Button
- 3-8 REC Button ( MAX, MIN Button )
- 3-9 Testing bottle with 0 NTU standard solution
- 3-10 Testing bottle with 100 NTU standard solution
- 3-11 Empty testing bottle 1
- 3-12 Empty testing bottle 2
- 3-13 Battery Compartment/Cover
- 3-14 Clean Cloth
- 3-15 Clean Solution ( Distill Water )

## 4. MEASURING PROCEDURE

### 4-1 Measurement Consideration

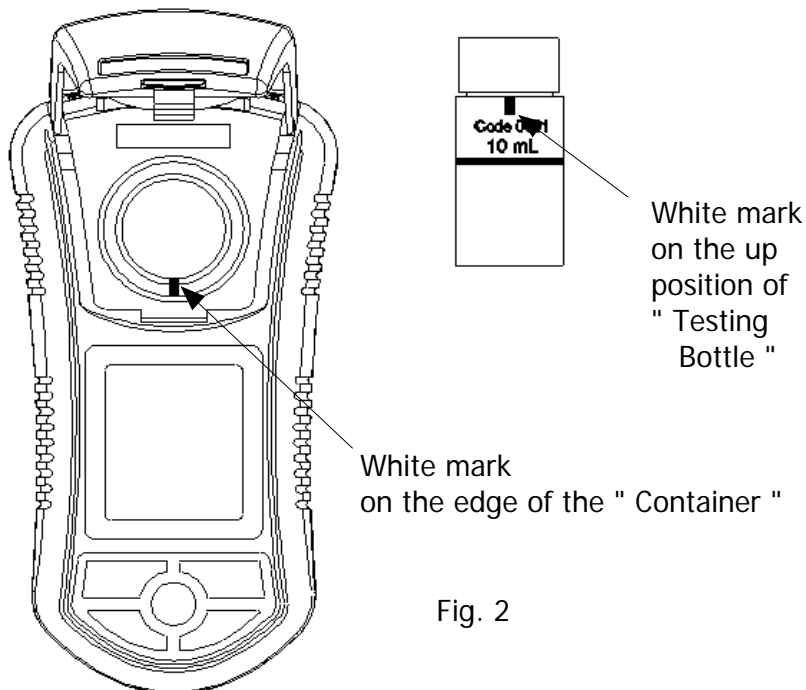

Fig. 2

- 1) There is a " White mark " on the edge of the " Container " ( 3-2, Fig. 1 ) and also on the up position of " Testing Bottle " ( 3-9, 3-10, 3-11, 3-12, Fig. 1 ), refer Fig. 2.
- 2) When make the measurement ( or calibration ), it should keep the " Container white mark " face to face together with the " Testing bottle white mark "



- 3) Insert the " Testing bottle " to the bottom of " Container " ( 3-2, Fig. 1 ) completely.
- 4) Before the measurement, it should envelop in the " Cover " ( 3-1, Fig. 1 ) completely.

**Remark :**



*Before the measurement, it should keep the outside of Testing Bottle under the dry condition and without existing any dust.*

**4-2 Measurement**

- 1) Fill the measurement liquid into the " Testing bottle " ( 3-11, 3-12, Fig. 1 ) .

**Attention :**

*It should fill the measurement liquid capacity until its level up to the " level marker " of the " Testing bottle "*

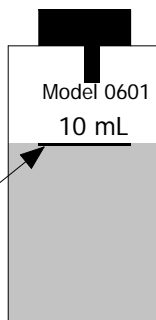

- 2) Insert the " Testing bottle " to the bottom of " Container " ( 3-2, Fig. 1 ) completely.
- 3) Before the measurement, it should envelop in the " Cover " ( 3-1, Fig. 1 ) completely.
- 4) Power ON the meter by pressing the " Power Button " ( 3-6, Fig. 1 ) once.
- 5) Press " TEST Button " ( 3-5, Fig. 1 ) once, the display will show the text " tEst " ( TEST)", following the " tEst " will flash approx. 10 seconds , then the TURBIDITY value will present on the display along with the " ntu " unit.

**Remark :**

- \* Under power OFF, if press the TEST Button " ( 3-5, Fig. 1 ) will power ON and going on to make the test automatically.
- \* After the testing, within ten minutes approx., the meter will auto power OFF automatically.



**Wash ( Reinse ) the Testing bottle**

- \* After the testing, it should wash ( reinse ) the Testing Bottle by the Clean Solution ( Distill Water ) " ( 3-17, Fig. 1 ).

**4-3 Zero**

When measure the " 0 NTU " liquid, if the display not show the zero value, it can deduct ( offset ) those " not zero value " with default, the zero procedures are :

Press the " ZERO Button " ( 3-7, Fig. 1 ) continuously until the display show zero value then release the finger from the button

\* Remark :

*The zero function can be executed within the zero diff value < 2.0 NTU only.*

**4-4 Data Hold**

During the measurement, press the " Hold Button " ( 3-4, Fig. 1 ) once will hold the measured value & the LCD will display a " HOLD " symbol.

- \* Press the " Hold Button " once again will release the data hold function.

**4-5 Data Record ( Max., Min. reading )**

- \* The data record function records the maximum and minimum readings. Press the " REC Button " ( 3-8, Fig. 1 ) once to start the Data Record function and there will be a " REC. " symbol on the display.



- \* With the " REC. " symbol on the display :
  - a) Press the " REC Button " ( 3-8, Fig. 1 ) once, the " REC. MAX. " symbol along with the maximum value will appear on the display.  
If intend to delete the maximum value, just press the " Hold Button " ( 3-4, Fig. 1 ) once, then the display will show the " REC. " symbol only & execute the memory function continuously.
  - b) Press the " REC Button " ( 3-8, Fig. 1 ) again, the " REC. MIN. " symbol along with the minimum value will appear on the display.  
If intend to delete the minimum value, just press the " Hold Button " ( 3-4, Fig. 1 ) once, then the display will show the " REC. " symbol only & execute the memory function continuously.

## 5. CALIBRATION PROCEDURE

1) The meter can be calibrated under two kinds standard solution :

- 0 NTU standard solution**
- 100 NTU standard solution**

2) The meter ship along with

- a. Testing bottle with 0 NTU standard solution x 1 PC**
- b. Testing bottle with 100 NTU standard solution x 1 PC**

as the standard accessories.

3) The complete calibration should be executed by following two solution :

- 0 NTU standard solution**
- 100 NTU standard solution**

4) **Shaking the calibration bottle lightly**

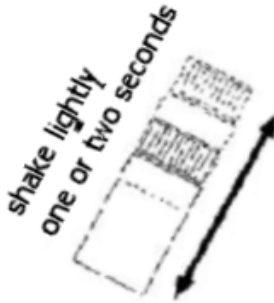

**Before execute the calibration, it should shake lightly ( not strongly ) the**

*Standard solution ( TU-0NTU, TU-100NTU )*

**one to two seconds to let the calibration solution under the uniform condition.**

*Remark :*

*Do not shake the Standard solution strongly due to it may generate the " Air bubble " and let the solution existing not accurate value.*

5) **The buttons that will be used during the Calibration procedures**

*Escape button, select button :*

Fig. 1, 3-4 Hold Button ( Esc Button )

*Calibration button, Enter button :*

Fig. 1, 3-5 TEST/CAL Button ( Enter Button )

6) **0 NTU calibration**

- a. Insert the " 0 NTU standard solution into the " Container " ( 3-2 , Fig. 1 ) and envelope in the " Cover " ( 3-1, Fig. 1 ) completely, other procedures please refer to above section 4-1, 4-2.

- b. Press " CAL Button " ( 3-5, Fig. 1 ) continuously (at least 3 seconds ) until the Display show the text " CAL " then release the button.



Fig. 5-1

- c. After the LCD show above Fig. 5-1, wait a while the display will show

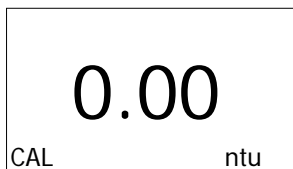

Now the meter is ready for the " 0 NTU " calibration

- d. Press " CAL Button " ( 3-5, Fig. 1 ) once, the Display will show following text with flashing ( approx. 10 seconds ).



*flashing*

Then the Display will show :



Now the meter is finished the " 0 NTU " calibration procedures and ready for " 100 NTU " calibration procedures.

7) **100 NTU calibration**

When finish the " 0 NTU " calibration procedures and the Display show :

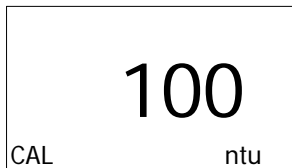

The meter is ready for " 100 NTU " calibration.

- \* Insert the " 100 NTU standard solution into the " Container " ( 3-2 , Fig. 1 ) and envelope in the " Cover " ( 3-1, Fig. 1 ) completely.  
Press " CAL Button " ( 3-5, Fig. 1 ) once, the Display will show following text with flashing ( approx. 10 seconds ).



Then the LCD display will return to normal measurement screen, now the meter is finished the calibration procedures ( 0 NTU, 100 NTU calibration ) completely and ready for the measurement.

- 8) **During the calibration, if exit something wrong ( Error, can not be calibrated..... ), please check if the " Standard solution " value is wrong, if still can not fix the problem , then execute the execute the " Calibration clear " procedures ( Section 6 ) may can fix the problem.**

## 6. CALIBRATION CLEAR

Execute the calibration procedures will clear all the calibration value ( Section 5 ) , the system will return to the Default value.

- a. Power On ( no matter if the " Testing bottle " insert into the " Container " or not ) press the " CAL Button " ( 3-5, Fig. 1 ) continuously (at least 3 seconds ) until the Display show the text " CAL " then release the button, the display will show :



Fig. 6-1

- b. After the LCD show above Fig. 6-1, wait a while the display will show :

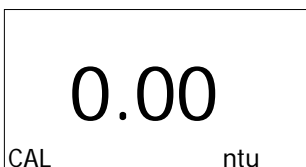

Press " Hold Button " ( 3-4, Fig. 1 ) once the display will show :



Press " Hold Button " ( 3-4, Fig. 1 ) once again the display will show :



**Now the meter is ready for the " Calibration clear "**

Press " CAL Button " ( 3-5, Fig. 1 ) once, the Display will show following text with flashing ( approx. 10 seconds ).

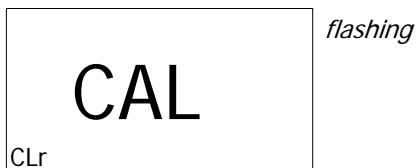

Then the LCD display will return to normal measurement screen, now the meter is finished the calibration clear procedures and clear all the existing calibration data.

## 7. BATTERY REPLACEMENT

- 1) When the left corner of LCD display show " - 2) Loss the " Battery Cover Screws " and slide the " Battery Cover " ( 3-13, Fig. 1 ) away from the instrument and remove the battery.
- 3) Replace with DC 1.5 V battery ( UM4, AAA, Alkaline/heavy duty ) x 6 PCs, and reinstate the cover.
- 4) Make sure the battery cover is secured after changing the battery.