

Oil Type Protractor With Magnets



VAL-60



VAL-50



VAL-30



VAL-10



VAL-20

ORDER NO.	LxWxH	BASE	ACU	WEIGHT (kg)	CODE NO.
VAL-10	78x62x14mm	ABS	0.2°	0.2	2033-100
VAL-30	93x79x15mm	ABS	0.1°	0.2	2033-101
VAL-50	93x79x16mm	METAL	0.083°	0.4	2033-102
VAL-60	140x130x20mm	METAL	0.05°	1	2033-103
VAL-20	70x65x30mm	ABS	0.2°	0.2	2033-104
	13mm/1/2"x3M/10'				

- The pointer is rotating in a hydraulic oil for stable, precise and error-eliminating reading, even to a differential subgraduation less than one degree. The two pointers or the vernier versus the annular graduations are read super imposedly with minimum reading error.
- Double annular graduations are provided for preventing visual reading error.
- The transparent temperature-resistant oil may visually amplify the pointer for a better optical reading.
- The double-rail magnet may attract this angle level on a round pipe or a surface of ferrous material.
- An extension rule could be inserted into the bottom slot for measurement and drawing line for wider area.

1. RESET: For setting a pseudo-horizon, upon which a new angle on the pseudo-horizon can be directly measured.
2. DOUBLE CHECK: Double annular graduations provided for calibrating either positive or negative degrees.

MULTI-FUNCTION ANGLE LEVEL

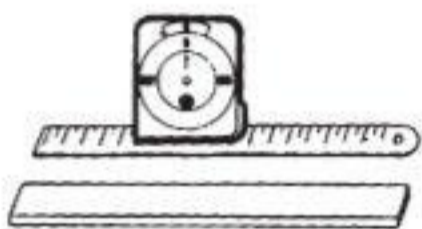

A Thin iron plate (The magnet power the thicker the weaker) may be attracted under the angle level for wider measurement.

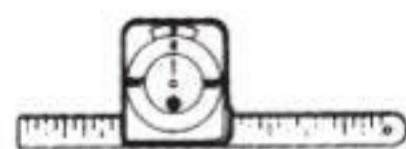

Inserting a straight extension rule into a bottom slot if the angle level.

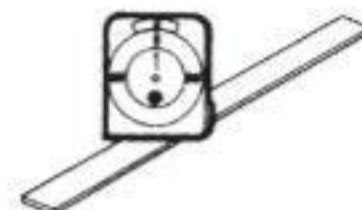

Attracting the angle level on an iron plate for measuring an angle inside a tank.

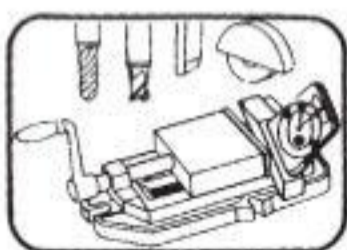

1. Suitable for working machines

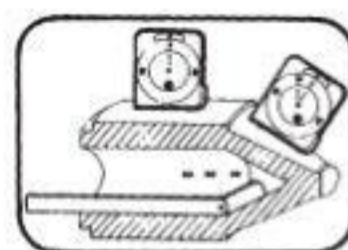

2. Grinding machine

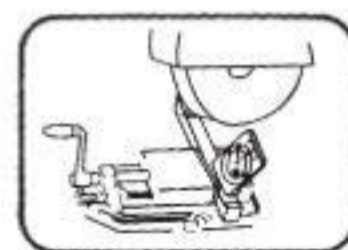

3. Out & inner cone angle

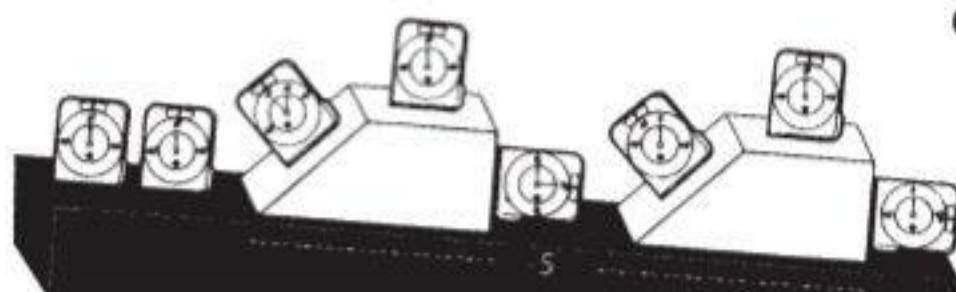

A standard angle block laid on a Non-horizontal Plane showing several measured positions by this angle level.

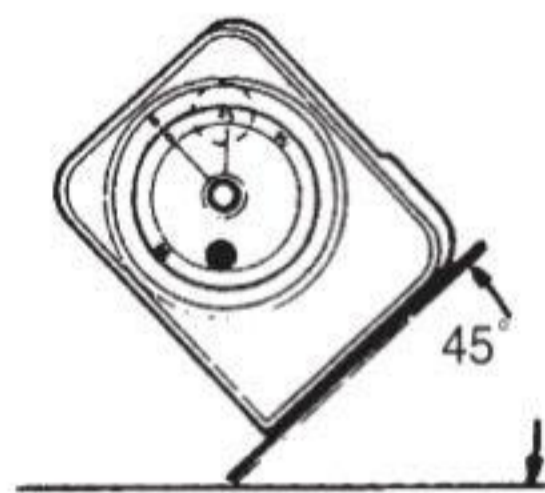

Finding an angle

Align the movable degree scale 0° reading, in line with the fixed vernier, 0° mark. Set your instrument's bottom surface on the object to be measured. Your reading off the pointer is your angle of inclination from 0°

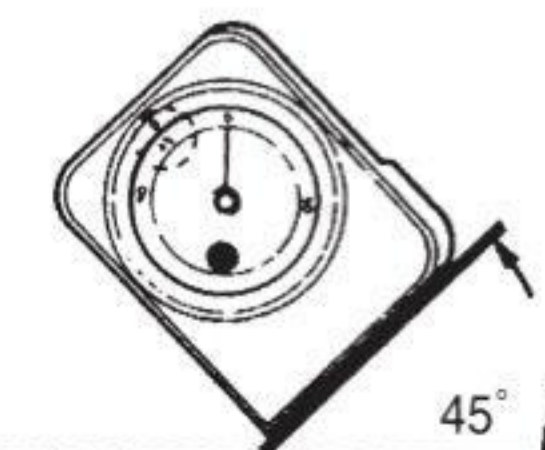

Setting Specific angles

Align the desired angle on the movable scale to the vernier 0° mark. Tilt the instrument until the pointer is aligned with the 0° mark.

OVERLAP