



PCE Americas Inc.
711 Commerce Way
Suite 8
Jupiter
FL-33458
USA
From outside US: +1
Tel: (561) 320-9162
Fax: (561) 320-9176
info@pce-americas.com

PCE Instruments UK Ltd.
Units 12/13
Southpoint Business Park
Ensign way
Hampshire / Southampton
United Kingdom, SO31 4RF
From outside UK: +44
Tel: (0) 2380 98703 0
Fax: (0) 2380 98703 9
info@industrial-needs.com

www.pce-instruments.com/english
www.pce-instruments.com

Manual

Cable Detector PCE-CL 20



Version 1.0
Date of creation: 21.06.2016
Date of last change: 21.06.2016

Contents

1	Safety notes	3
2	Specification	4
2.1	Technical specifications	4
2.2	Delivery contents	4
3	System description	5
3.1	Receiver unit	5
3.2	Transmitter unit	7
4	Getting started	8
4.1	Batteries / Power supply	8
4.2	Measurement method	8
4.3	Optional connections to the cable locator	9
4.3.1	Single-pole use	9
4.3.2	Two-pole use	9
5	Operation	9
5.1	Single-pole use	9
5.1.1	In open current circuits	9
5.1.2	Locating and tracing of lines and sockets	10
5.1.3	Locating the cable breaks	11
5.1.4	Detection of cable breaks with the help of two transmitters.	12
5.1.5	Troubleshooting of the underfloor heating	13
5.1.6	Detection of a blocked part in an installed non-metallic piping	14
5.1.7	Finding metallic tap water- and heating pipe	15
5.1.8	Finding power supply circuits on the same floor	16
5.1.9	Tracking an underground current circuit	17
5.2	Bipolar use	18
5.2.1	Use in closed current circuits	18
5.2.2	Detection of fuses	19
5.2.3	Increase of the effective radius when tracking the loaded current circuits	23
5.3	Additional measuring functions	24
5.3.1	Voltage measurement with the transmitter	24
5.3.2	Lamp function	24
5.3.3	Backlight	24
5.3.4	Mute	24
5.3.5	Automatic shutdown	24
6	Maintenance	24
6.1	Finding errors / Troubleshooting	24
6.2	Fuse	25
7	Warranty	26
8	Disposal	26
9	Contact	26
9.1	PCE Instruments UK	26
9.2	PCE Americas	26

Thank you for purchasing a cable locator from PCE Instruments.

1 Safety notes

Please read this manual carefully and completely before you use the device for the first time. The device may only be used by qualified personnel and repaired by PCE Instruments personnel. There is no warranty of damages or injuries caused by non-observance of the manual.

- This device may only be used in the way specified in this manual. If used otherwise, this may cause dangerous situations.
- Use the device only when the environmental conditions (temperature, air humidity, ...) are within the limit values range stated in the specifications. Do not expose the device to extreme temperatures, direct sunlight, extreme air humidity or moisture.
- The case should only be opened by qualified personnel of PCE Instruments.
- Do not touch the instrument with wet hands.
- You should not make any technical changes to the device.
- The appliance should only be cleaned with a damp cloth. Do not use any solvent-based cleaners or abrasives.
- The device must only be used with original PCE accessories or equivalent.
- Before each use, please inspect the case for damage. In case of any visible damage, please do not use the device.
- Do not expose the instrument to explosive atmospheres.
- The limits for the measured parameters given in the specifications may not be exceeded under any circumstances.
- Do not expose the device to the extreme temperatures or direct sunlight, dust, strong electromagnetic radiation, splash water, high humidity or condensation, corrosive or explosive gases or mechanical vibration.
- Before the device is used on the current-carrying components, the corresponding isolation preparations must be met.
- Never attempt to make contact between the two poles of the battery elements, for example, via a cable connection.
- Should the instructions be ignored and not followed, it may lead to the damage of the device and injury of the operator.

This manual is published by PCE Instruments without any guarantee.

We expressly point to our general guarantee terms which can be found in our general terms of business.

If you have any questions, please contact PCE Instruments.

Safety symbols

Symbol	Description
	<p>Warning: electrical voltage Non-observance can cause electric shock.</p>

2 Specification

2.1 Technical specifications

Transmitting unit	
Output signal	125 kHz
External voltage identification range	DC 12 ... 400 V $\pm 2,5$ % AC 12 ... 400 V (50 ... 60 Hz) $\pm 2,5$ %
Display	LCD
Maximum voltage	Max. 400 V AC/DC
Overvoltage category	CAT III 300 V
Pollution degree	2
Power supply	9 V battery
Power consumption (minimum voltage)	Approx.. 31 mA
Power consumption (maximum voltage)	Approx.. 115 mA
Fuse	F 0.5 A 500 V, 6.3 x 32 mm
Operating conditions	0 ... +40 °C, <80 % RH
Storage conditions	-20 ... +60 °C, <80 % RH
Dimensions	190 x 89 x 42.5 mm
Weight	Approx. 420 g (incl. battery)
Receiver	
Detection depth	Depends on material and particular application
Single-pole application	Approx. 0 ... 2 m
Two-pole application	Approx. 0 ... 0.5 m
Single loop line	Up to 2.5 m
Grid voltage detection	Approx. 0 ... 0.4 m
Display	LCD
Power supply	6 x 1.5 V AAA batteries
Power consumption (minimum voltage)	Approx. 32 mA
Power consumption (maximum voltage)	Approx. 89 mA
Operating conditions	0 ... +40 °C, <80 % RH
Storage conditions	-20 ... +60 °C, <80 % RH
Dimensions	241.5 x 78 x 38.5 mm
Weight	Approx. 350 g (incl. batteries)

2.2 Delivery contents

- 1 x cable locator PCE-CL 20 (1 x transmitter and 1 x receiver unit)
- 2 x alligator clips
- 2 x measuring tips
- 2 x test leads
- 1 x grounding rod
- 1 x carrying strap
- 1 x carrying bag
- 1 x 9 V battery
- 6 x 1.5 V AAA batteries
- 1 x user manual

3 System description

3.1 Receiver unit

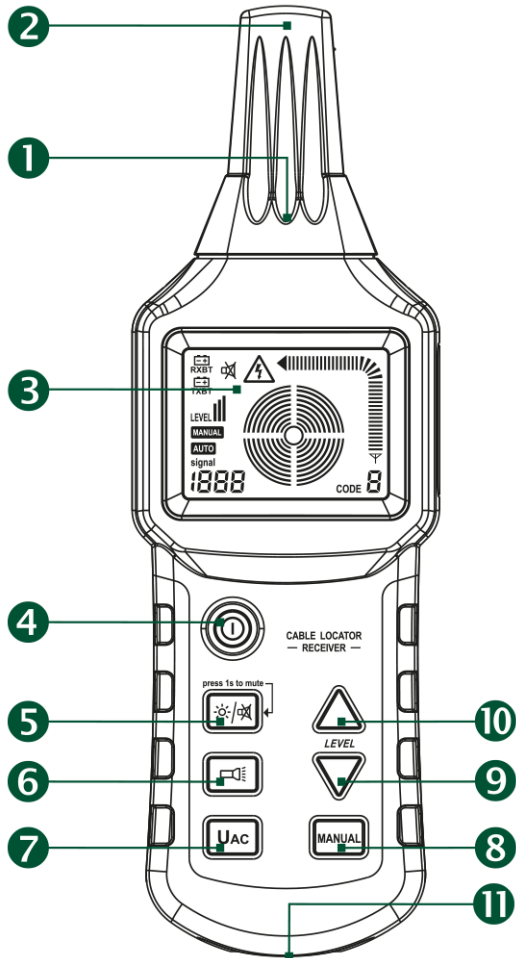

1. Lamp
2. Measuring sensor
3. LCD
4. POWER button
5. Backlight / mute
6. Lamp on / off
7. UAC button
8. Manual / automatic measurement
9. Decrease sensitivity (manual measurement)
10. Increase sensitivity (manual measurement)
11. Speaker

Receiver display description

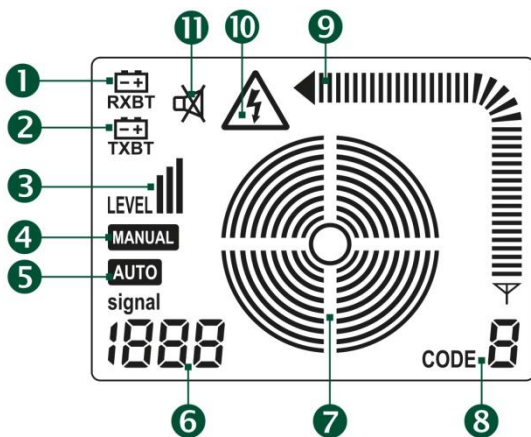

1. Battery voltage receiver
2. Battery voltage transmitter
3. Received transmitting power
4. Symbol for the manual measuring mode
5. Symbol for the automatic measuring mode
6. Automatic measuring mode: signal intensity
Manual measuring mode: display of "SEL"
7. UAC mode: display of "UAC"
7. Sensitivity (more circles = higher sensitivity)
8. Receive code
9. Signal intensity
10. Mains voltage symbol
11. Mute symbol

Receiver display in cable search mode

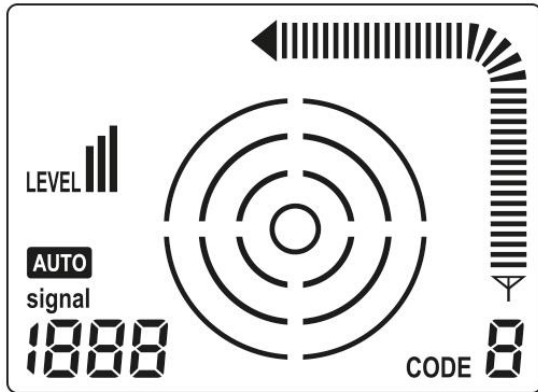

1

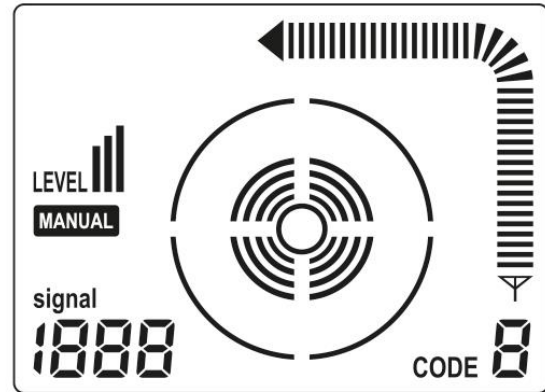

2

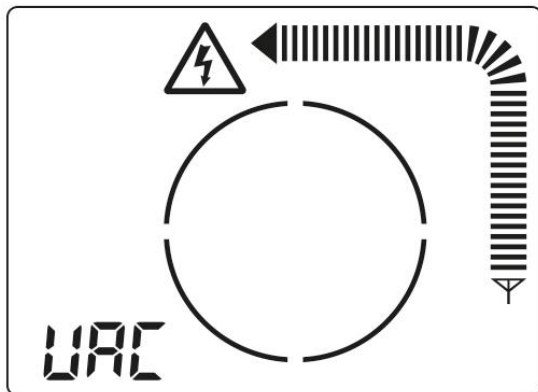

3

1. Automatic measuring mode
2. Manual measuring mode
3. UAC measuring mode (mains voltage identification)

3.2 Transmitter unit

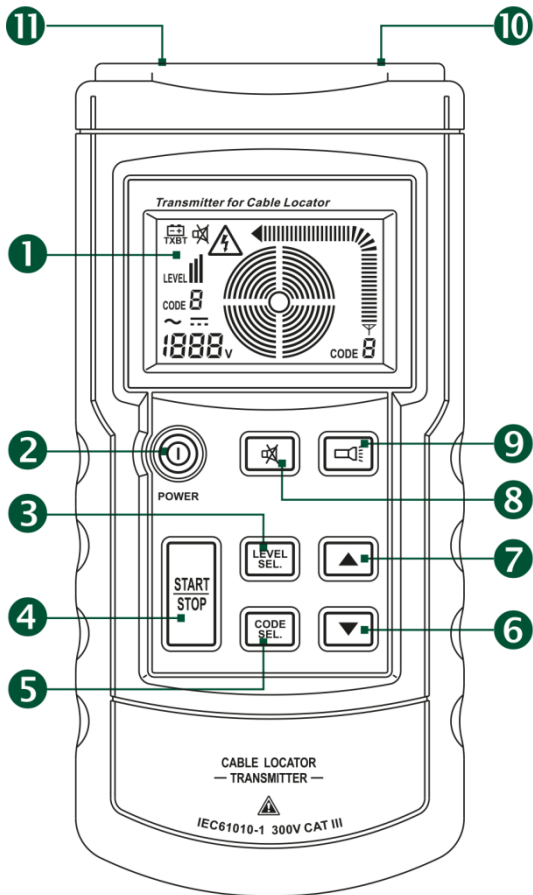

1. LCD
2. POWER-button
3. Set / confirm the transmission power
4. Start / Stop the transmission of the code information
5. Set / confirm the code information
6. DOWN – button
7. UP – button
8. Mute button
9. lamp on / off
10. input / output opening
11. grounding hole

Transmitter display description

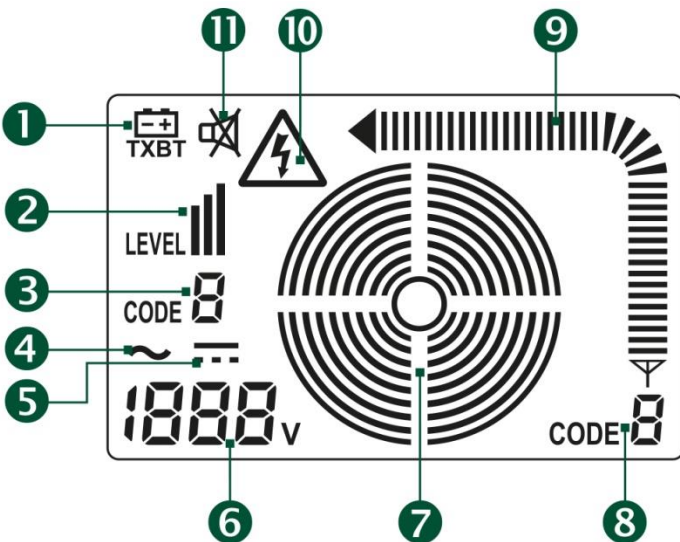

1. Transmitter battery voltage
2. Transmission power
3. Transmission code
4. Mains AC voltage
5. Mains DC voltage
6. Mains voltage value
7. Transmitting status
8. Transmitted code
9. Signal intensity
10. Mains voltage indication
11. Mute indication

4 Getting started

4.1 Batteries / Power supply

To insert the batteries, you need a screwdriver. First, the base must be opened, before you can open the battery compartment of the transmitter. Loosen the fastening screw and remove the cover of the battery compartment. After that, the battery can be inserted. The receiver unit also has a battery cover, which is secured with a screw. After the screw is loosened, the battery cover can be removed and the batteries can be inserted. Once the batteries are inserted, the respective covers must be put back in place and secured by the screws.

Mind the correct polarity of the batteries when replacing them. If the polarity is not correct this might damage the device. Also, mind the common guidelines for handling batteries to prevent damage or injuries. Only use such batteries, as defined in the specifications of this manual. If the unit is not used for a longer period of time the batteries should be removed to prevent battery leakage.

When the low battery indication flashes on the display, the batteries must be replaced. The device also gives out an acoustic signal when the battery voltage is low. Please make sure that the device is turned off and all the test leads are disconnected from the device when replacing the batteries.

4.2 Measurement method

The Cable Locator PCE-CL 20 is a two-part instrument, consisting of a transmitter and a receiver unit. Additionally, it comes with a variety of measuring accessories.

When locating a cable, the transmitter applies an AC voltage (modulated by digital signals) to the cable or metal tube to be found, which generates an alternating electric field. When the receiver is held near the cable or pipe, the electrical field generates a voltage. The receiver can amplify the signal by hundreds of times. By detecting changes in the signal while moving the receiver, it can detect the position of the cable or pipe. The cable locator can only detect cables and pipes which are connected to the transmitter properly. For each application, the connections of the transmitter must ensure a closed circuit.

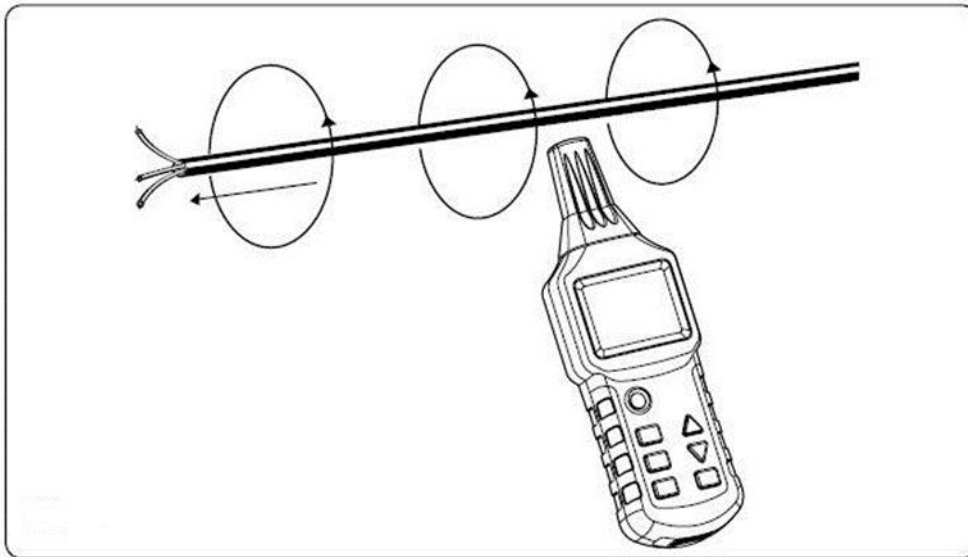

4.3 Optional connections to the cable locator

4.3.1 Single-pole use

The transmitter is connected to only one conductor. Due to the high frequency signal generated by the transmitter, only one conductor can be located and tracked. The second conductor is the ground. This arrangement produces a high-frequency current which flows through the conductor and is transmitted to the ground, similar to a radio or receiver.

4.3.2 Two-pole use

The transmitter is connected to a conductor with two test leads. This method can be used with both current-carrying and voltage-free cables.

Current-carrying cables

Connect the "+" opening of the transmitter to the phase of the mains cable and the ground opening of the transmitter to the neutral conductor of the mains cable. In this case, if the mains cable is not loaded, the modulated current goes from the transmitter via coupling through the distributed capacitance in the mains cable to the neutral cable and then returns to the transmitter.

Voltage-free cables

Connect the positive output of the transmitter with a mains cable. Connect the ground output with another parallel mains cable. After that, the modulated current returns directly through the mains cable to the transmitter. Optionally, both test leads of the transmitter can be connected both ends of a conductor. Also, the positive output of the transmitter can be attached to the connector of the mains cable, if the grounding output of the transmitter can be connected to the protective grounding connector of the mains cable.

5 Operation

5.1 Single-pole use

5.1.1 In open current circuits

- Detecting and locating cable breaks in walls and floors
- Locating and tracing cables, sockets, junction boxes, switches, etc.
- Locating bottlenecks, kinking, buckling and obstructions in pipes with the help of a metal wire

Make sure that the protective ground cable is working properly.

The use in the open circuit is suited for finding current-free sockets and switches.

The tracking depth depends on the medium and application. Typically, it is between 0 and 2 m. The protective connection of the socket can be used as a ground connection for the transmitter.

5.1.2 Locating and tracing of lines and sockets

**ATTENTION:**

- The circuit must not be live.
- The neutral cable and the protective grounding cable must be connected and fully functional.
- Connect the transmitter to the phase cable and the protective grounding cable as shown in the picture below:

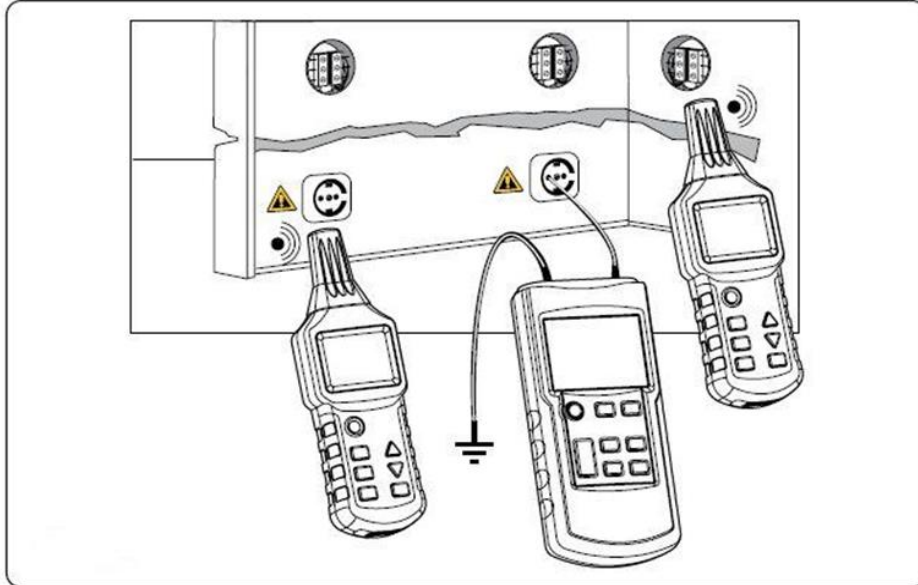

In case of a single-pole application the lateral circuit branches can be tracked (the fuse must be removed in this example).

If the power cable that is supplied with the signals from the transmitter is located, for example, directly parallel to the other conductors (e.g. cable slot or channel) or if these conductors are crossed, the signals are also sent to the other conductors.

During the search and tracing, the closer the locator gets to the cables to be tracked, the stronger the signal is displayed.

Set the transmission power in order to adapt it to different search radii.

The target position can be located accurately by using the manual mode and adjusting the sensitivity.

5.1.3 Locating the cable breaks

**ATTENTION:**

- The circuit must not be live.
- The cables that are not used, must be connected to the auxiliary ground (as seen in the figure below).
- Connect the transmitter to the cable connection and to the auxiliary ground.

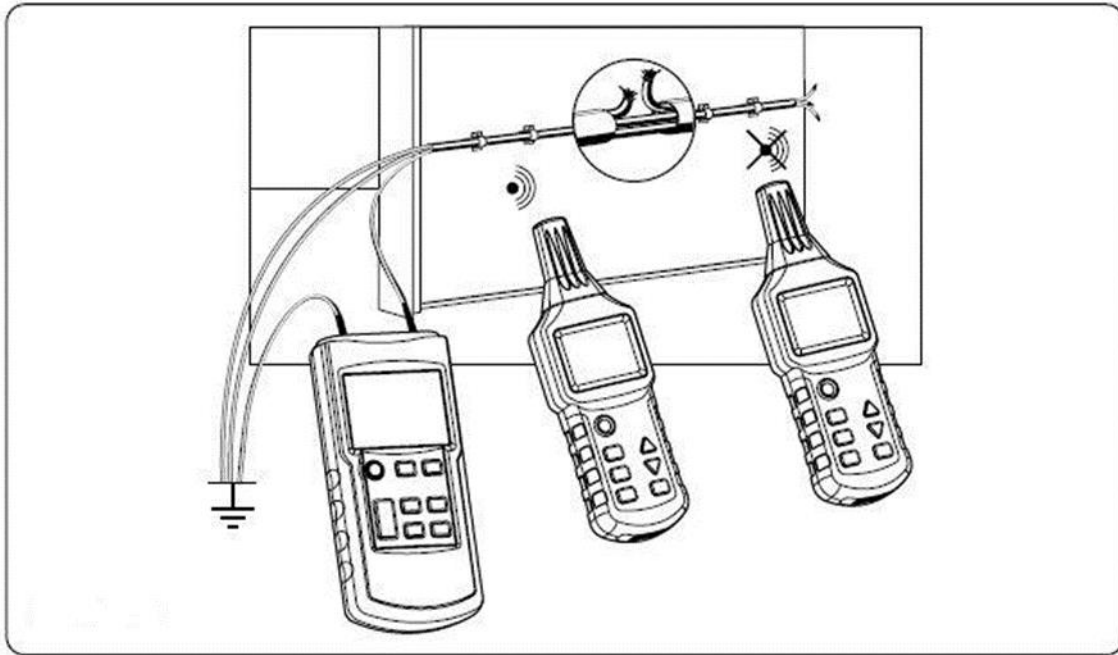

The transition resistance of a cable break must be higher than 100 k Ω .

Note during the tracking of cable breaks in multicore cables, that all the remaining wires in the shielded cable or conductor must be grounded properly. This is required to avoid cross coupling of the supplied signals (through a capacitive effect on the output terminals). The tracking depth for shielded cables and conductors is different, as the individual wires in the shielded are looped around each other.

The ground connected to the transmitter can be an auxiliary ground, the ground of a grounded socket or a properly grounded water pipe.

During the tracing of the cable, an abrupt drop of an incoming signal at the receiver takes place at the point of interruption.

Set the transmission power in order to adapt it to different search radii.

The target position can be located accurately by using the manual mode and adjusting the sensitivity.

5.1.4 Detection of cable breaks with the help of two transmitters.

In the process of searching for a cable break with a transmitter, which is powered from the end of the cable, the breaks cannot be tracked accurately when bad conditions prevail due to a field disturbance. The impairments described above can be easily avoided if two transmitters (one on each end) are used to detect the cable interruption. In this case, each transmitter is set to a different cable code, e.g. Transmitter 1 to code F and Transmitter 2 to code C. (A second transmitter with a different cable code is not included in the delivery and must be ordered separately.)



ATTENTION:

- The circuit must not be live.
- All unused cables must be connected to the auxiliary ground as shown in the following figure.
- Connect both transmitters according to the figure.

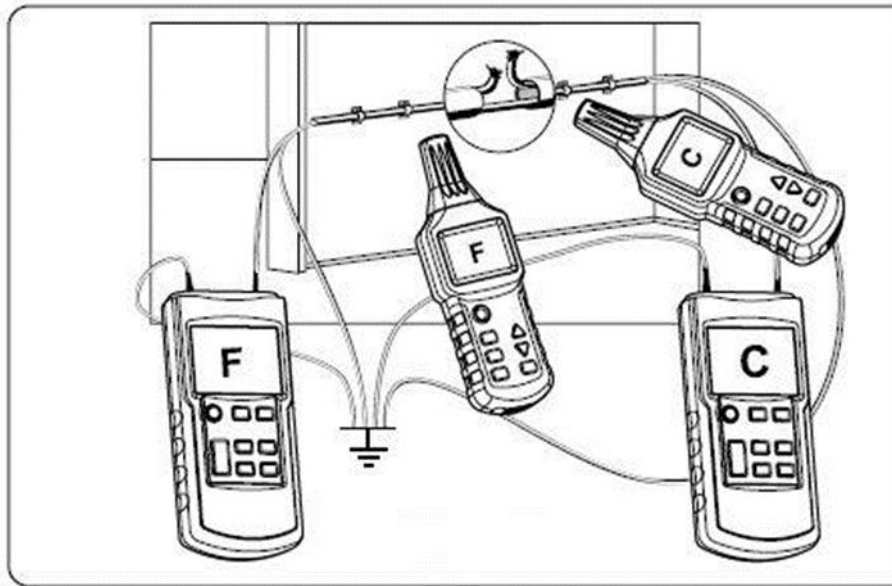

When the transmitters are connected in accordance with the figure, the receiver indicates "C" on the right side of the cable break. If the receiver goes to the left over the break point, it shows "F". If you are directly at the break point no cable code will be displayed because of the overlap of both transmitter signals.

- Set the transmission power in order to adapt it to different search radii.
- The target position can be located accurately by using the manual mode and adjusting the sensitivity.
- The transition resistance of a cable interruption must be higher than 100 kΩ.
- The ground connected to the transmitter can be an auxiliary ground, the ground of a grounded socket or a properly grounded water pipe.
- Note when tracking the cable breaks in multicore cables, that all remaining wires in the shielded cable or conductor must be grounded properly. This is required to avoid the cross coupling of the supplied signals (through a capacitive effect on the output terminals). The tracking depth for shielded cables and conductors is different, as the individual wires in the shielded cables are looped around each other.

5.1.5 Troubleshooting of the underfloor heating



ATTENTION:

- The circuit must not be live.
- All unused cables must be connected to the auxiliary ground as shown in the following figure.
- Connect both transmitters in accordance with the figures.

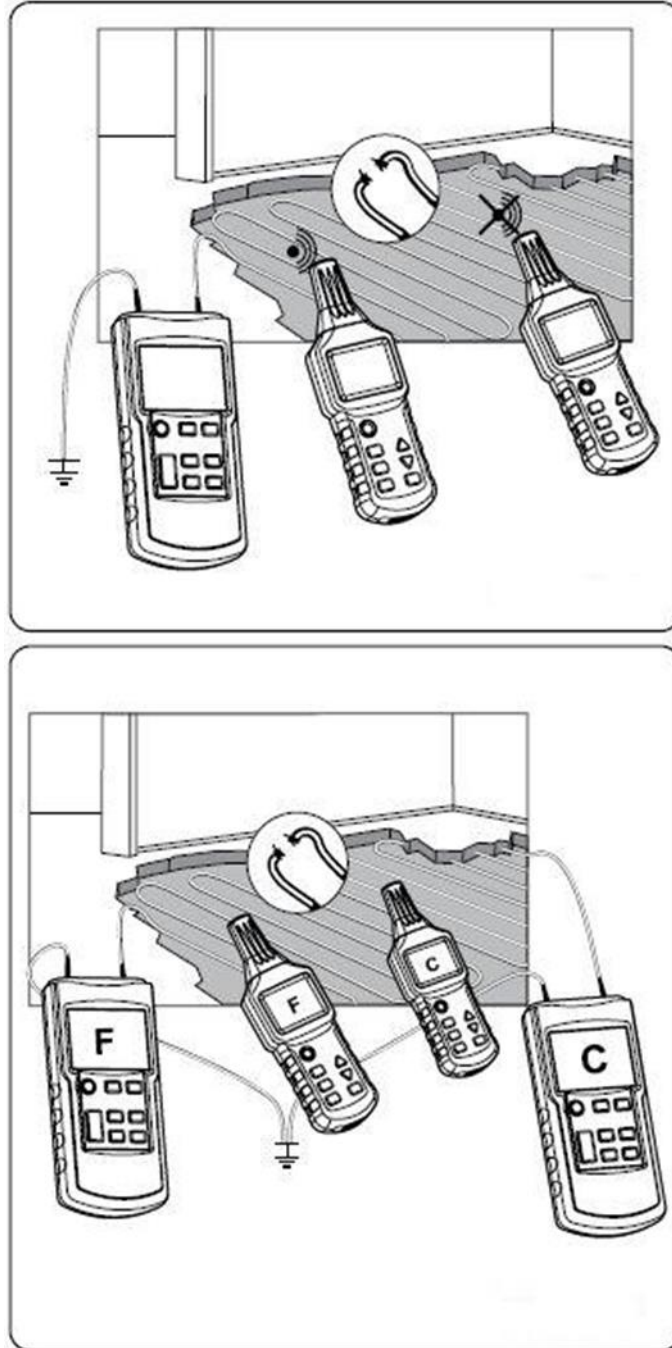

- If a shielding mat is located above the heating wires, there may be no ground connection. If necessary, disconnect the shield from the ground connection.
- It is necessary to ensure a full grounding, and there should be a sufficient distance between the ground terminal of the transmitter and the target cable. If this distance is too small, the signal and the line cannot be detected accurately.
- During tracing the line an abrupt drop of the incoming signal at the receiver marks the point of interruption.

- Set the transmission power in order to adapt it to different search radii.
- The target position can be located accurately by using the manual mode and adjusting the sensitivity.

5.1.6 Detection of a blocked part in an installed non-metallic piping

ATTENTION:

- The pipe must be made of non-conductive materials (such as plastic).
- The pipe must be drained.
- The transmitter is connected to a metallic conductor (metallic pipe or flexible protective tube) and an auxiliary grounding cable as shown in the following figure.

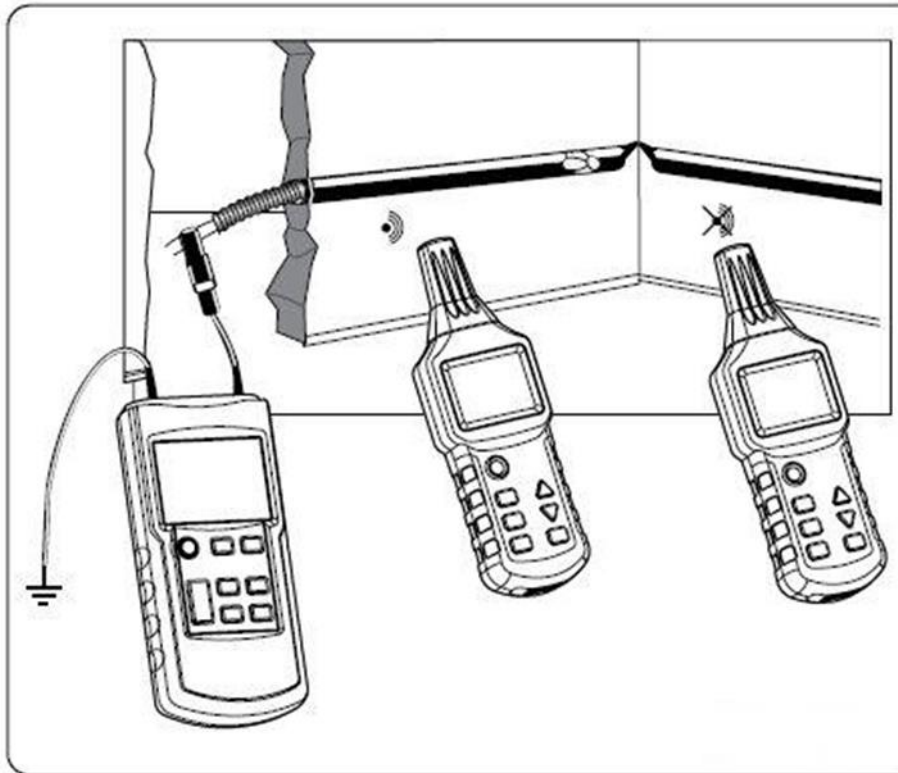

- If there is power in the pipeline, turn the power off and perform a proper grounding, when the pipeline is drained.
- The end of the ground cable must be grounded properly, and there should be a sufficient distance between the grounding end of the transmitter and the pipeline to be measured. If the said distance is too small, the signal and the circuit cannot be located accurately.
- If you only have a tube, which is made of non-conductive material (such as, fiberglass for example), we recommend to install a metal wire with a diameter of about 1.5 mm into the non-conductive tube and then push it into the narrow part.
- The stronger the signals are displayed on the display of the locator during the tracking of the pipeline, the closer the tracked pipeline is to the locator.
- If the incoming signals at the receiver suddenly become weaker in the course of searching along the pipeline, blocked spot is located.
- Set the transmission power in order to adapt it to different search radii.
- The target position can be located accurately by using the manual mode and adjusting the sensitivity.

5.1.7 Finding metallic tap water- and heating pipe

ATTENTION:

- The pipeline must be made of metallic materials (for example, piping made of galvanized steel).
- The pipeline must not be grounded. There should be a relatively high resistance between pipe and floor (otherwise the search distance is very small).
- Use a connection cable to connect the grounding socket on the transmitter with the ground and ground the end of the grounding cable properly.
- Use a connection lead to connect the socket "+" on the transmitter to the pipeline.

The tracing of the installed tap water pipe and the heating pipe is shown in the following figures

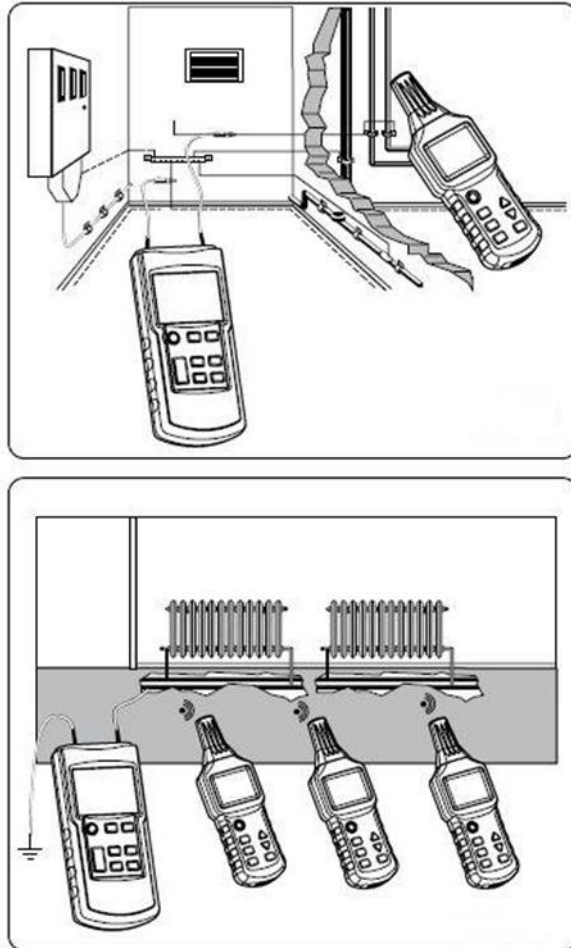

- The end of the grounding cable of the transmitter should be located at a certain distance to the tracked pipeline. If the distance is too short, the signals and the circuit cannot be accurately located.
- The stronger the signals are displayed on the display of the locator during the tracking of the pipeline, the closer the tracked pipeline is to the locator.
- Set the transmission power in order to adapt it to different search radii.
- The target position can be located accurately by using the manual mode and adjusting the sensitivity.

5.1.8 Finding power supply circuits on the same floor

**ATTENTION:**

Turn off the power in the entire building before measuring.

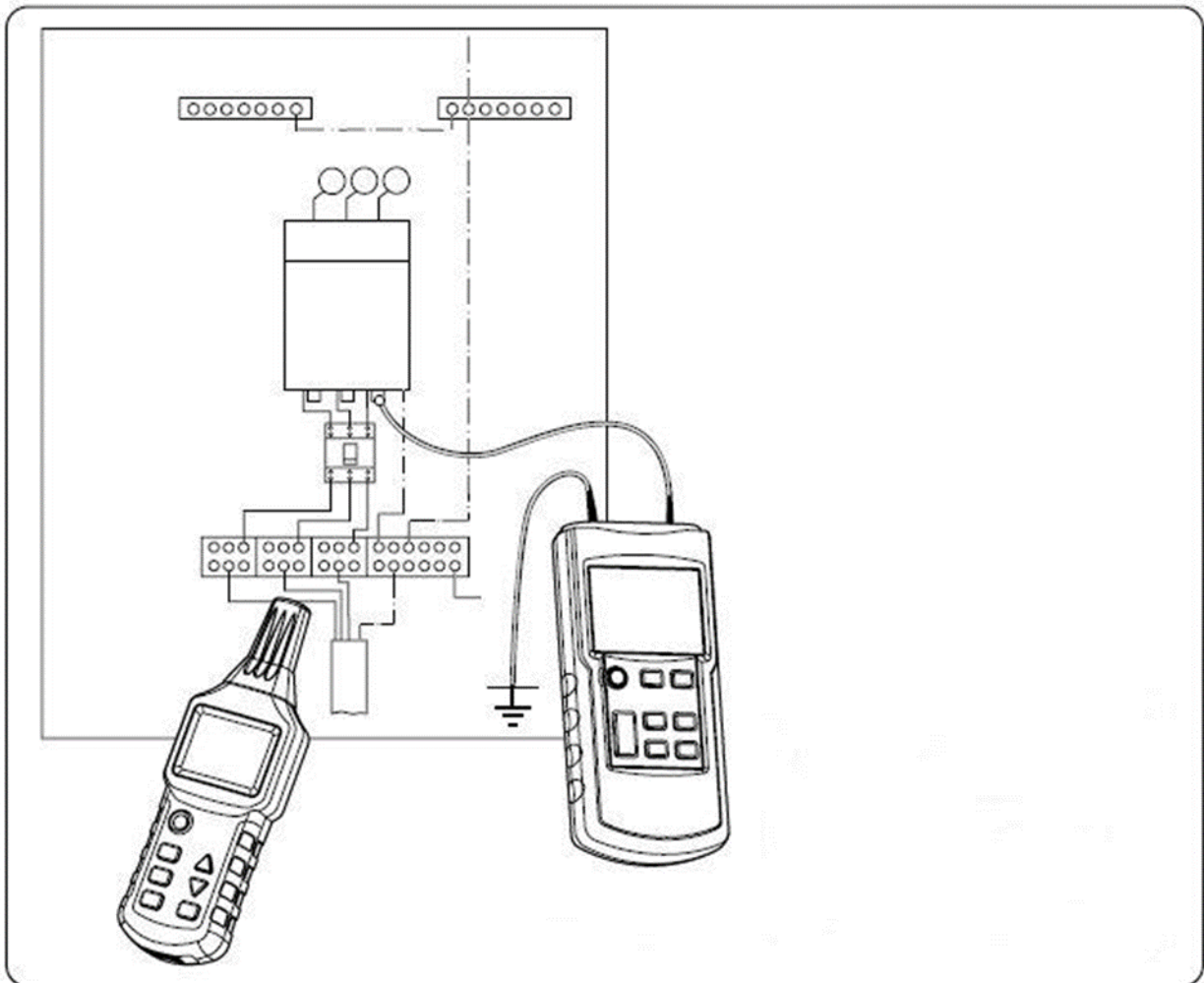

- The end of the grounding cable of the transmitter must be grounded properly and should be located at a certain distance from the tracked pipeline. If the distance is too small, the signals and the current circuit cannot be accurately located.
- The stronger the signals are displayed on the Display of the locator during the tracking of the pipeline, the closer the tracked pipeline is to the locator.
- Set the transmission power in order to adapt it to different search radii.
- The target position can be located accurately by using the manual mode and adjusting the sensitivity.

5.1.9 Tracking an underground current circuit

**ATTENTION:**

- The power circuit must not be charged.
- Connect the transmitter as shown in the figure.
- The end of the grounding cable of the transmitter must be grounded properly.
- Select the automatic mode on the receiver.
- Use the displayed signal strength to search and trace the current circuit.

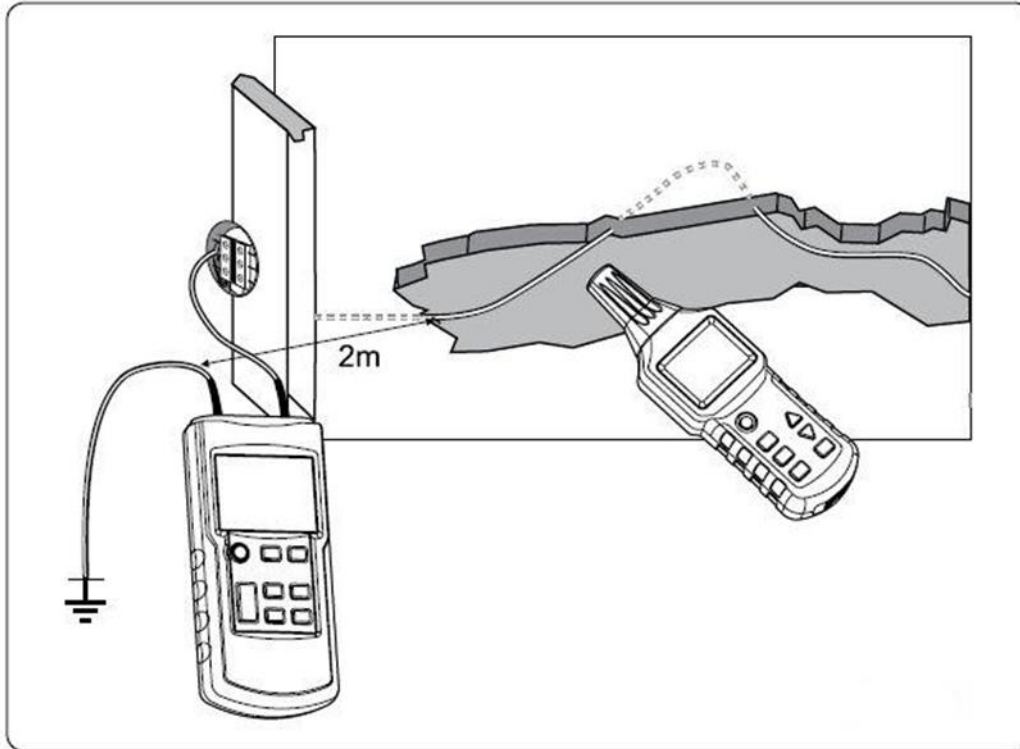

- The distance between the grounding cable and the searched circuit must be as big as possible. If the distance is too small, the signals and the current circuit cannot be accurately located.
- The search depth is highly dependent on the ground (floor, soil) conditions. Select appropriate reception sensitivities to locate the circuit accurately.
- If you move the receiver slowly along the searched current circuit, you will find that the display often changes. The strongest signals indicate the exact place of the current circuit.
- The bigger the distance between the supply signals (transmitter) and the receiver, the lower the signal strength and weaker the search will be.

5.2 Bipolar use

5.2.1 Use in closed current circuits

This method can be used in charged and uncharged circuits:

In uncharged circuits, the transmitter only sends the encoding signals to the circuit.

In charged circuits, the transmitter sends the encoding signals to the circuit, measures and also shows the voltage of the charged circuit, as can be seen in the following figure:

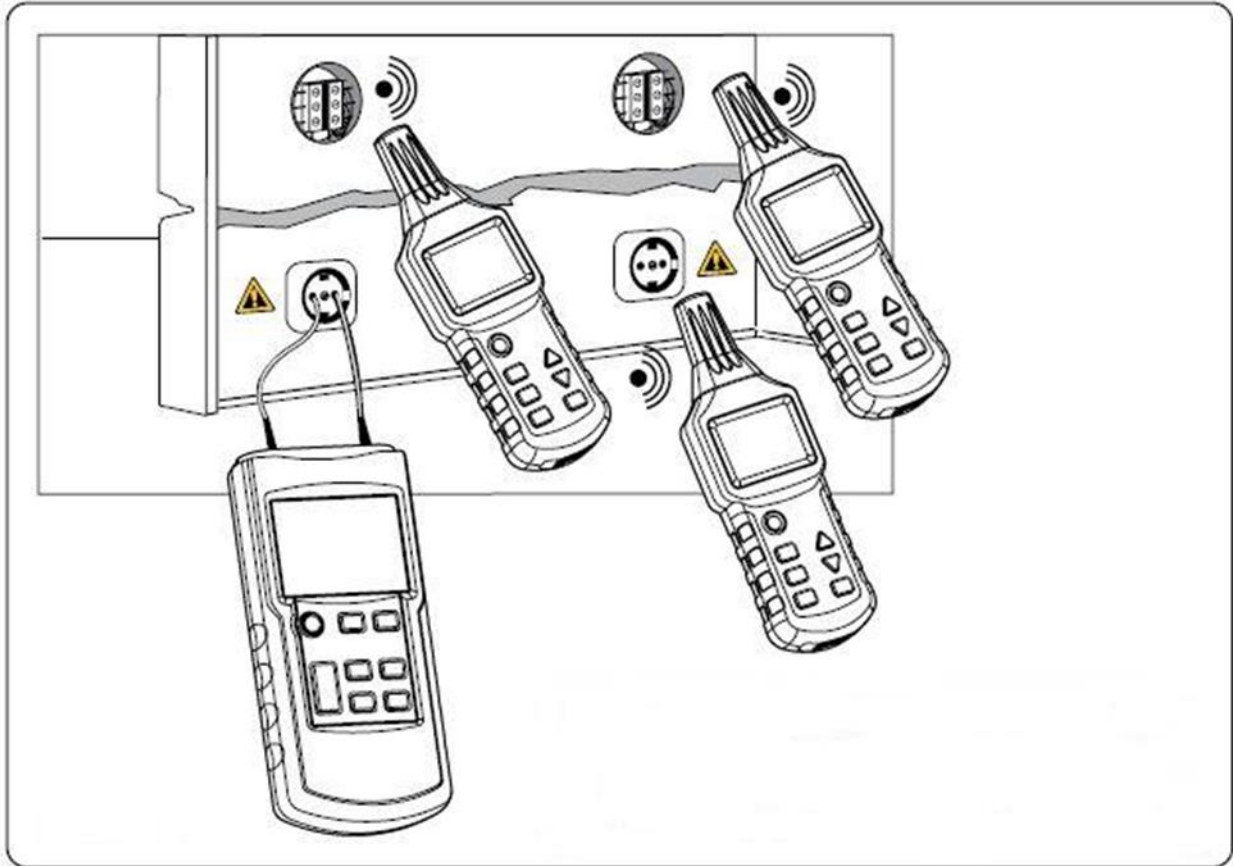

ATTENTION: Please follow the safety instructions when connecting the loaded circuits to the transmitter.

- The dielectric strength of the transmitter is 400 V AC / DC.
- The use in closed circuits is suitable for searching sockets, switches, fuses etc. in electrical installations of charged and uncharged floors.
- The search depth depends on the medium of the ran cable and its use. It is normally less than 0.5 m.
- Set the transmission power in order to adapt it to different search radii.

5.2.2 Detection of fuses

In a building with several apartments you use the terminals L and N in the socket of any apartment to provide the flow of the signals from the transmitter, and set the power of the transmitter at an appropriate level.

Preparation:

- Turn off all air switches in the distribution box.
- Connect the transmitter according to the following figure.

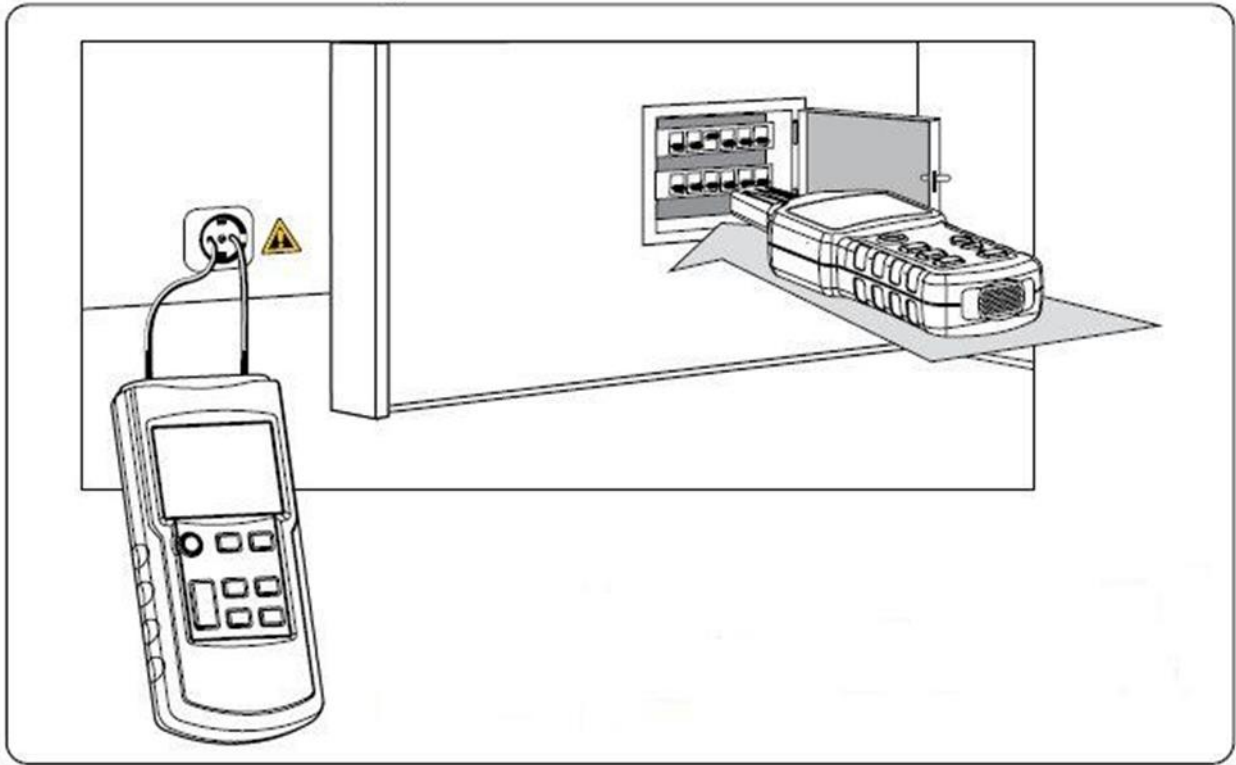

- The identification and positioning of fuses strongly depends on the wiring situation in the distribution box. To carry out the search of fuses as precisely as possible, the cover of the distribution box should be opened or removed and the supply cable of the fuse searched.
- During the search process the fuse with the strongest and most stable signals is the one that is searched. Due to signal coupling the locator can also detect the signals from other fuses, but the strength of these signals is usually relatively weak.
- When searching, it is better to insert the sensor of the locator in the inlet of the fuse box in order to achieve the best search result.
- Set the power of the transmitter in order to adjust it to different search radii. Select the manual mode on the receiver and the appropriate reception sensitivity to locate the current circuit accurately.

5.2.2.1 Searching for a short circuit in the current circuit

Preparation:

- The circuit must be unloaded.
- Connect the transmitter according to the following figure.

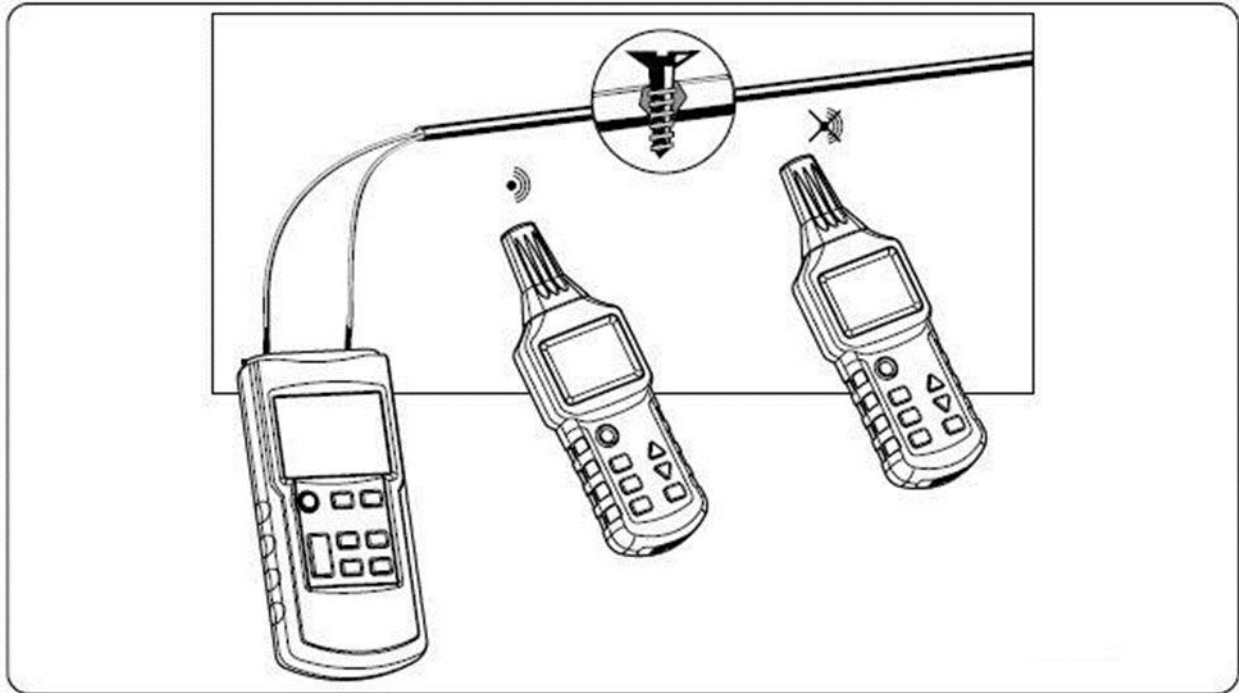

- If there is current in the cable, first turn the power off to make the cable unpowered.
- When searching for short circuits in the coated electric wires and cables the search depths vary, because the core wires in the jacket are twisted with each other. According to our experience only the short circuits with an impedance less than 20Ω can be tracked correctly. The impedance of the short circuit can be measured with a multimeter.
- If the impedance of the short circuit is higher than 20Ω , try to apply the method of searching for the breaks in current circuits to locate the short circuit. Use of a relatively strong current for that in order to connect the defective part (low Ω -connection) or to interrupt it.
- If the incoming signals at the receiver suddenly become weaker in the course of searching along the pipeline, the place, where a short circuit is located, is found.
- Set the power of the transmitter in order to adjust it to different search radii.
- Select the manual mode on the receiver and the appropriate reception sensitivity to locate the circuit accurately.

5.2.2.2 Finding low-lying current circuits

For bipolar use the search depth is strictly limited if the loop / ring cable consists of core wires in cables with multiple core wires (such as, for example, NYM 3 x 1.5 mm²), because a short distance between the supply cable and the loop cable causes a strongly distorted magnetic field. A sufficiently strong magnetic field cannot be established in the narrow places. If a separate loop cable is used, this problem could be resolved easily, since a separate conductor could spread the magnetic field much more. In case of the loop cable it may go about some type of conductive wires or cable rolls. It is important that the distance between the supply cable and the loop cable is bigger than the depth of laying. In practice, this distance is usually 2 m or more.

preparations:

- The circuit must be unloaded.
- Connect the transmitter as in the following figure.
- The distance between the supply cable and the loop cable must be at least 2 ~ 2.5 m.

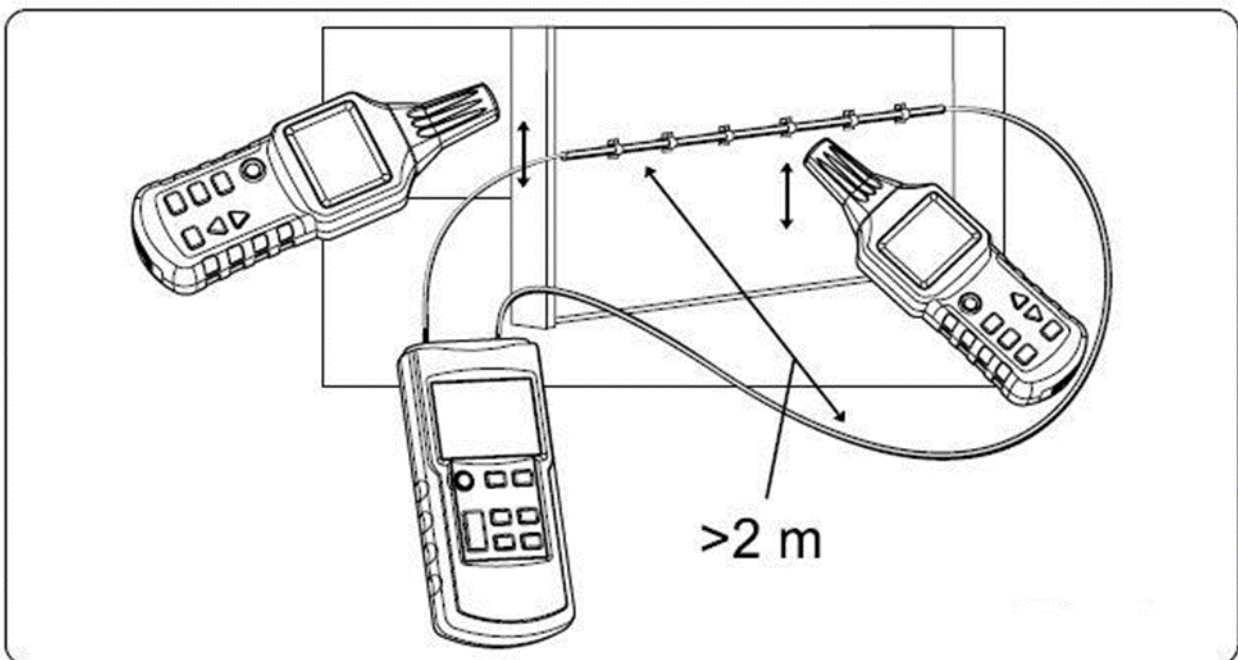

- For this type of application the influence of moisture or mortar on the wall up to the search depth is not important.
- The stronger the signals displayed on the Nixie Tube of the locator during the tracking of the current circuit is, the closer to the locator the tracked cable is.
- Set the power of the transmitter in order to adjust it to different search radii.
- Select the manual mode on the receiver and the appropriate reception sensitivity to locate the current circuit accurately.

5.2.2.3 Classify or define the laid current circuit

Preparation:

- The circuit must be unloaded.
- The ends of the core wires must be twisted with each other and conduct all together.
- Connect the transmitter as in the following figure.

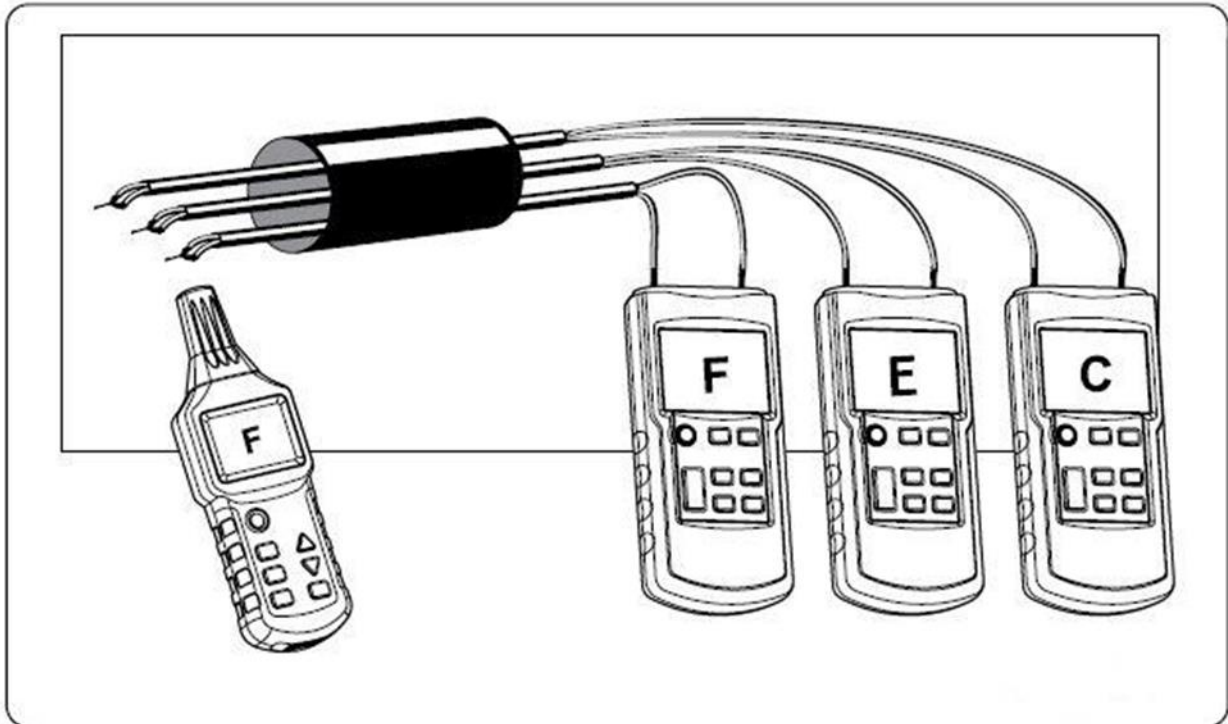

- If there is current in the cable, first turn off the power to make the cable unpowered.
- The ends of the non-shielded core wires must conduct together and need to be twisted with each other.
- If only one transmitter is used, carry out multiple measurements while changing the connection between the transmitter and the core wire of the cable.
- When changing the connection between the transmitter and the core wire of the cable various current circuits can be distinguished when the coding of the transmitter is changed in the process of transmission.
- Set the power of the transmitter in order to adjust it to different search radii.
- Buy a transmitter with different transmission signals, if necessary.

5.2.3 Increase of the effective radius when tracking the loaded current circuits

When the transmitter is connected directly to the phase cable and the neutral cable, the signals are led to two parallel current circuits. Therefore, the twisting of circuits can sometimes cause signals that counteract each other, which brings to the result that an effective search radius is at most 0.5 m. To eliminate this effect, the connection must be made as in the following figures, where the loop cable uses a separate cable to increase the effective radius to about 2.5 m. Loop cables for longer distances can be prepared with the help of a cable roll.

Follow and observe the safety instructions when connecting loaded current circuits to the transmitter.

Pay attention to the distance between the transmitter and the searched current circuit in order to be able to determine the current circuit over the signals clearly.

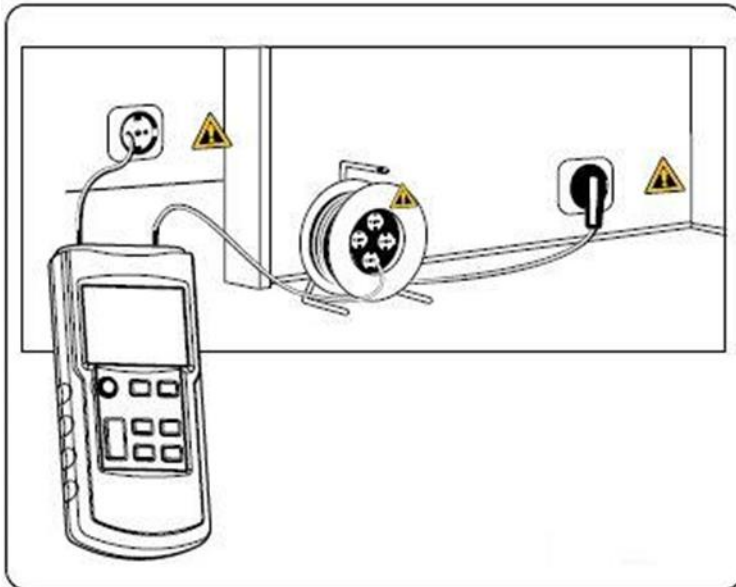
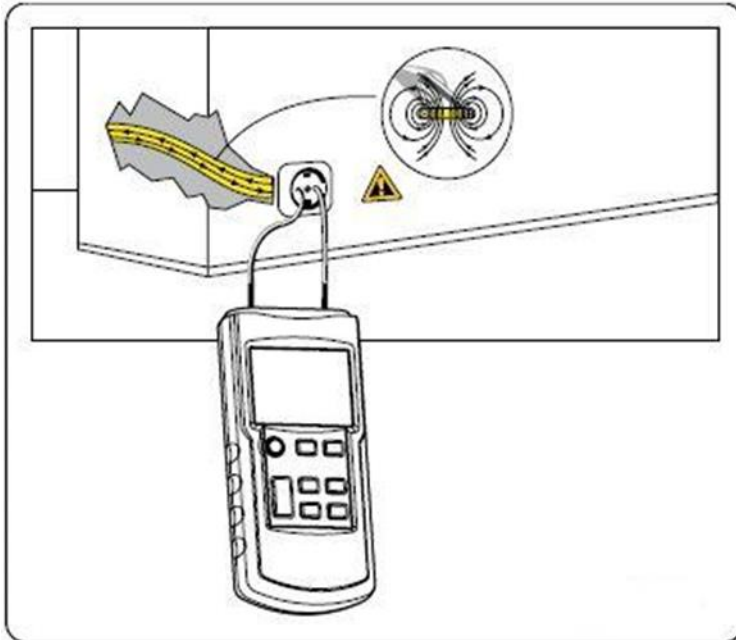

- The stronger the signals displayed on the display of the locator during the tracking of the current circuit, are, the closer the searched cable is to the locator.
- Set the power of the transmitter in order to adjust it to different search radii.
- Select the manual mode on the receiver and the appropriate receiver sensitivity in order to locate the current circuit accurately.

5.3 Additional measuring functions

5.3.1 Voltage measurement with the transmitter

When the transmitter is applied to a live (“voltage conducting”) current circuit and the external voltage is higher than 12 V, the current voltage value is displayed at the bottom on the left on the monitor of the transmitter. To distinguish between AC and DC circuits, the standardized symbols are used. Simultaneously, a flash appears on the display, which is enclosed by a triangle.

5.3.2 Lamp function

Both devices have the option to activate a lamp in the form of three LEDs at the upper end of the meter. Thus, also dark areas may be illuminated. In order to turn this function on, an appropriate button for the lamp function must be pressed. To turn the lamp off again, the button for the lighting function must be pressed again.

5.3.3 Backlight

The receiver unit is equipped with the backlight option. To activate the backlight, just a corresponding button should be pressed. The transmitter has no backlight function.

5.3.4 Mute

On the transmitter, mute function can be activated via the button for muting. After that, the device does not make any sound when the button is pressed. Renewed pressing of the same button activates the sound again.

On the receiver, the backlight / mute button must be pressed for one second. Thus the tones are turned off. Renewed pressing for one second brings this setting back.

5.3.5 Automatic shutdown

Of both devices only the receiver has an automatic shutdown function. This works only then, when for about 10 minutes no activity via button pressing or similar takes place. To switch transmitter off the Power button must be used.

6 Maintenance

6.1 Finding errors / Troubleshooting

If the device does not measure correctly, the following points should be checked first:

Problem	Please check:	Solution
The device cannot be turned on	Are all the batteries used?	Insert new batteries
	Is the battery voltage too low?	
	Are the batteries inserted with correct polarity?	Check, if the polarity is correct
The transmitter does not display the external voltage	Is there a sufficient contact?	Connect the cable again
	Is the measuring sensor defective?	Replace the measuring sensor.
	Is the measuring sensor inserted completely?	Insert the measuring sensor completely
	Is the test lead defective?	Renew the test lead
	Is the test lead inserted completely?	Insert the test lead completely
The power supply is interrupted during the measurement	Is the battery voltage too low?	Insert new batteries
	Has the device turned off automatically?	Turn the device on again
The transmitter cannot display any signals transmitted by it.	Was the button for transmission pressed?	Start the transmission again
	Is the fuse of the device defective?	Send the device back

6.2 Fuse

The fuse on the transmitter can prevent its damage caused by overload or false application. If the fuse of the transmitter does not function correctly any longer, the transmitter itself can produce only weak signals. If the self-test of the transmitter was successful, but it still sends only weak signals, it means that the transmission works, but the fuse does not work correctly any more. If not signal was found during the transmission in the process of self-test and the device has got the batteries with sufficient battery voltage, it means that the transmitter is defective and must be repaired by the qualified personnel or replaced.

Procedures and steps for checking the fuse:

1. Interrupt all the measuring correct circuits of the transmitter.
2. Turn the transmitter on and set it into the transmission mode.
3. Set the power of the transmitter to I.
4. Connect the end of the test lead to the connector of the transmitter.
5. Insert the other end of the test lead in the connecting socket of the transmitter.
6. Turn the transmitter on to search the signals from the test lead. After that, move the sensor of the receiver to the test lead.
7. If the fuse is not defective, the value displayed on the receiver, is doubled.

7 Warranty

Our warranty terms you may find in our Terms and Conditions which can be either found on the site: <https://www.pce-instruments.com/f/t/us/terms-conditions.htm>

8 Disposal

For the disposal of batteries, the 2006/66/EC directive of the European Parliament applies. Due to the contained pollutants, batteries must not be disposed of as household waste. They must be given to collection points designed for that purpose.

In order to comply with the EU directive 2012/19/EU we take our devices back. We either re-use them or give them to a recycling company which disposes of the devices in line with law.

If you have any questions, please contact PCE Instruments.

9 Contact

If you have any questions about our range of products or measuring instruments, please contact PCE Instruments.

9.1 PCE Instruments UK

By post:

PCE Instruments UK Ltd.
Units 12/13 Southpoint Business Park
Ensign Way, Southampton
Hampshire

United Kingdom, SO31 4RF

By phone:

02380 987 035

9.2 PCE Americas

By post:

PCE Americas Inc.
711 Commerce Way
Suite 8
Jupiter
33458 FL
USA

By phone:

561 320 9162



Alle PCE-Produkte sind CE
und RoHS zugelassen.